

# Vacuum Automation 2.1

The future depends on good product choices





Introduction .....	256
COAX® MICRO .....	258
COAX® MINI .....	266
COAX® MIDI .....	284

## Introduction



Piab vacuum pumps are predominantly based on the patented COAX® technology

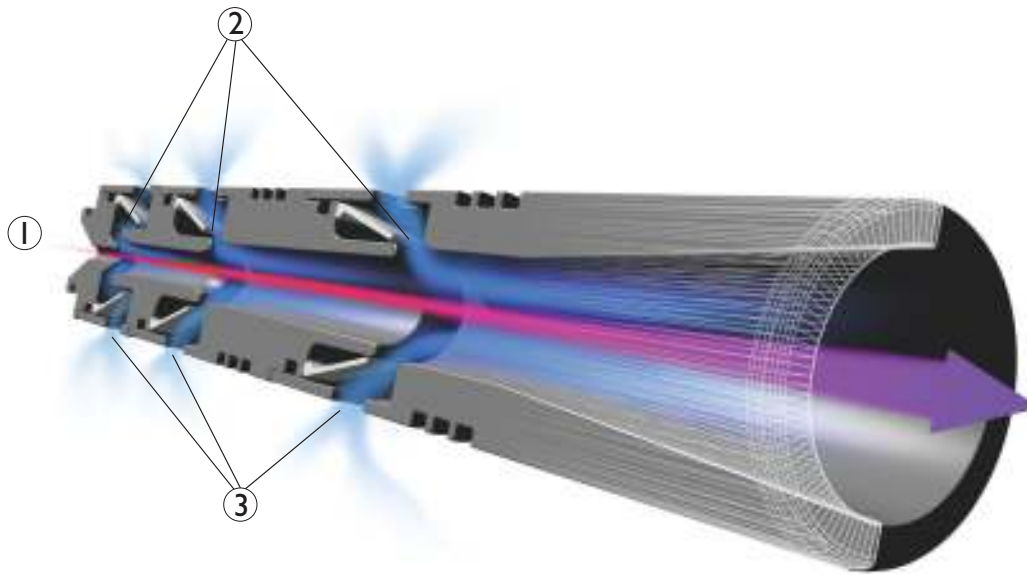

When compressed air (1) passes through the nozzles (2), air is pulled through with the stream of compressed air. "Suction" is thus created at the opening of each stage (3).

COAX® cartridges exist in several sizes (MICRO, MINI & MIDI) and models (Bi, Ti, Pi, Si, & Xi), making them suitable for every application. The technology ensures excellent performance at both low and high feed pressures – ideal for situations where compressed air lines deliver air at low or fluctuating pressures. Pumps based on COAX® technology can operate within the range of 0.17 to 0.60 MPa.

power exactly where needed, making maximum use of energy and increasing speed by eliminating line losses and inefficiencies. For more information visit [www.coaxtechnology.com](http://www.coaxtechnology.com).

Piab's decentralized vacuum gripper system (VGS™) is a product solution integrating high-quality DURAFLEX® suction cups with COAX®-based vacuum cartridges. The VGS™ makes selection, sizing and installation of a vacuum system easier. With a VGS™, you will enjoy the benefits of a more cost-efficient and reliable vacuum system.



Piab centralized pumps are also based on COAX® technology. These are modularized pumps with COAX® cartridges; how many cartridges depend on the vacuum flow needed.



Integrating COAX® technology directly into the machine body allows you to position vacuum

## Bi03-2



- ▶ Two-stage COAX® cartridge - MICRO - probably the world's smallest multistage vacuum ejector.
- ▶ Vacuum level to 83 -kPa at extremely low feed pressure.
- ▶ High operational reliability in case of fluctuating or low compressed-air pressure.
- ▶ The low weight makes it suitable to integrate close to the suction point in high speed pick-and-place applications of small objects.
- ▶ Suitable for handling sealed objects.

### Technical data

Description	Unit	Value
Feed pressure, max.	MPa	0.7
Temperature range	°C	-10-80
Weight	g	1.5-2.3
Material		AI, NBR, PA, SS, TPE

### Vacuum flow

Feed pressure MPa	Air consumption NI/s	Vacuum flow (NI/s) at different vacuum levels (-kPa)								Max vacuum -kPa
		0	10	20	30	40	50	60	70	
0.11	0.10	0.17	0.10	0.040	0.027	0.013	—	—	—	50
0.18	0.14	0.23	0.15	0.060	0.040	0.035	0.023	0.013	0.0060	83
0.22	0.17	0.27	0.19	0.090	0.040	0.025	0.020	0.010	0.0050	82

### Evacuation time

Feed pressure MPa	Air consumption NI/s	Evacuation time (s/l) to reach different vacuum levels (-kPa)								Max vacuum -kPa
		10	20	30	40	50	60	70	80	
0.11	0.10	0.70	2.9	5.9	11.0	28.0	—	—	—	50
0.18	0.14	0.50	1.4	3.9	6.4	10.0	16.0	28.0	51.0	83
0.22	0.17	0.40	1.1	3.3	6.4	11.0	18.0	32.0	62.0	82

### Blow flow

Feed pressure MPa	Air consumption NI/s	Blow flow (NI/s) at different pressure levels (kPa)												Max pressure kPa
		0	20	40	60	70	80	90	100	110	120	130	140	
0.6	0.37	0.61	0.59	0.54	0.46	0.42	0.41	0.41	0.41	0.41	0.41	0.41	0.41	140

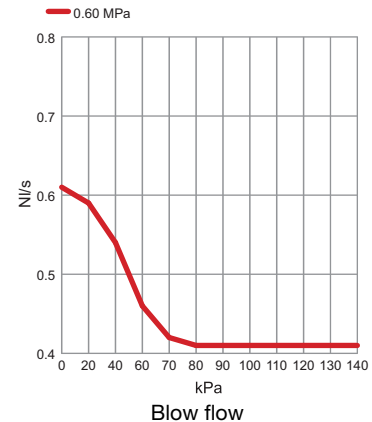
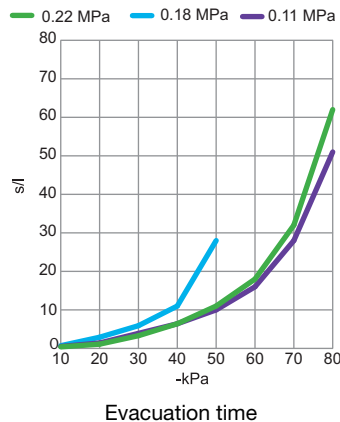
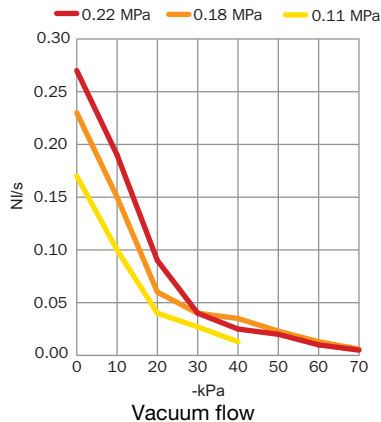

## Ordering information

	Description	Art. No.
A	COAX® cartridge MICRO Bi03-2	0106966
B	COAX® cartridge MICRO Bi03-2, holding cap	0106968

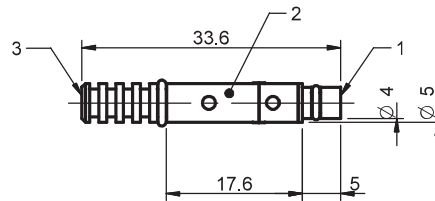
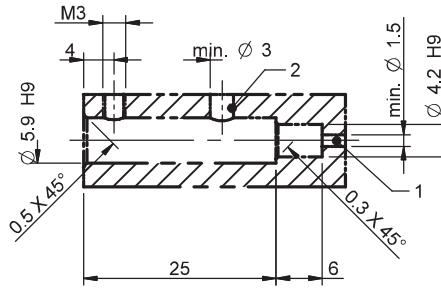
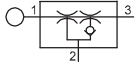

A

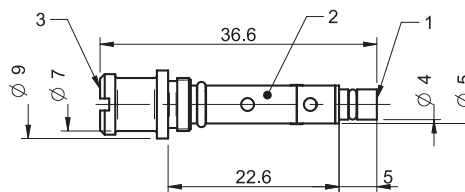
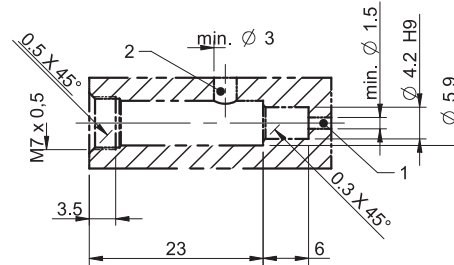
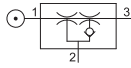

B

## Si02-2



- ▶ Two-stage COAX® cartridge - MICRO - probably the world's smallest multistage vacuum ejector.
- ▶ Large vacuum flow in relation to energy consumption.
- ▶ Good for handling porous materials or if surface leakage is present.
- ▶ The low weight makes it suitable to integrate close to the suction point in high speed pick-and-place applications of small objects.

### Technical data

Description	Unit	Value
Feed pressure, max.	MPa	0.7
Temperature range	°C	-10-80
Weight	g	1.5-2.3
Material		Al, NBR, PA, SS, TPE

### Vacuum flow

Feed pressure MPa	Air consumption NI/s	Vacuum flow (NI/s) at different vacuum levels (-kPa)								Max vacuum -kPa
		0	10	20	30	40	50	60	70	
0.4	0.09	0.25	0.15	0.08	0.07	0.05	0.03	—	—	60
0.5	0.10	0.27	0.19	0.09	0.08	0.07	0.05	0.02	—	70
0.6	0.12	0.28	0.21	0.12	0.08	0.07	0.06	0.04	0.02	75

### Evacuation time

Feed pressure MPa	Air consumption NI/s	Evacuation time (s/l) to reach different vacuum levels (-kPa)							Max vacuum -kPa
		10	20	30	40	50	60	70	
0.4	0.09	0.50	1.37	2.70	4.40	6.90	—	—	60
0.5	0.10	0.43	1.15	2.33	3.70	5.30	8.20	—	70
0.6	0.12	0.41	1.01	2.01	3.30	4.90	6.90	10.2	75

### Blow flow

Feed pressure MPa	Air consumption NI/s	Blow flow (NI/s) at different pressure levels (kPa)								Max pressure kPa
		0	10	20	30	40	50	60	70	
0.6	0.12	0.40	0.34	0.22	0.21	0.20	0.18	0.17	0.15	70

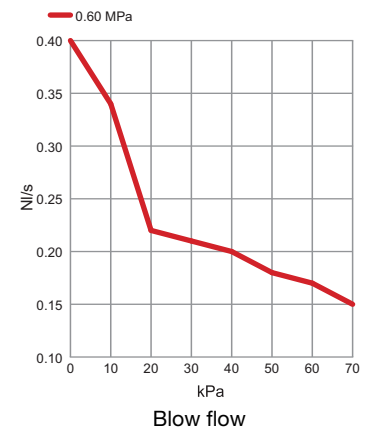
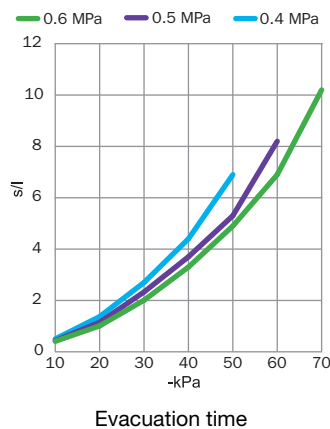
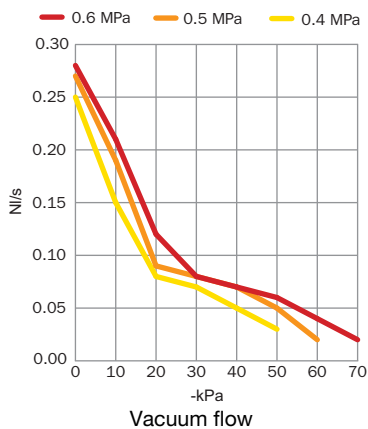



## Ordering information

	Description	Art. No.
A	COAX® cartridge MICRO SiO2-2	0113591
B	COAX® cartridge MICRO SiO2-2, holding cap	0113593

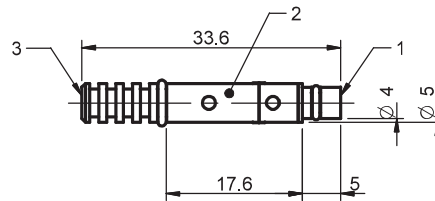
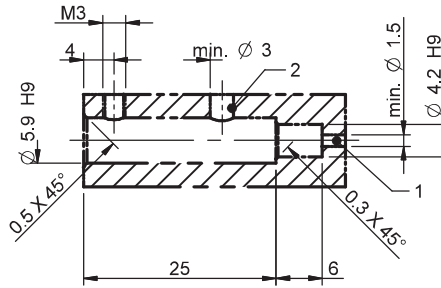
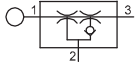

A

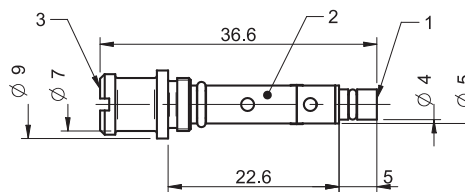
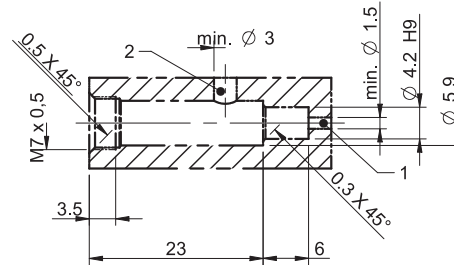
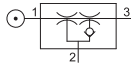

B

## Ti05-2



- ▶ Two-stage COAX® cartridge - MICRO - probably the world's smallest multistage vacuum ejector.
- ▶ Larger flow and evacuation capacity vs. the other MICRO cartridges.
- ▶ The low weight makes it suitable to integrate close to the suction point in high speed pick-and-place applications of small objects.
- ▶ Dirt tolerant cartridge design .
- ▶ Suitable for leaking objects at 0.6MPa feed pressure and sealed objects at 0.4 MPa feed pressure.

### Technical data

Description	Unit	Value
Feed pressure, max.	MPa	0.7
Temperature range	°C	-10-80
Weight	g	1.5-2.3
Material		AI, NBR, PA, SS, TPE

### Vacuum flow

Feed pressure MPa	Air consumption NI/s	Vacuum flow (NI/s) at different vacuum levels (-kPa)										Max vacuum -kPa
		0	10	20	30	40	50	60	70	80		
0.4	0.27	0.32	0.28	0.23	0.17	0.10	0.07	0.04	0.02	0.004	84	
0.6	0.37	0.31	0.27	0.24	0.20	0.15	0.09	0.04	0.01	-	75	

### Evacuation time

Feed pressure MPa	Air consumption NI/s	Evacuation time (s/l) to reach different vacuum levels (-kPa)									Max vacuum -kPa
		10	20	30	40	50	60	70	80		
0.4	0.27	0.33	0.73	1.20	2.00	3.10	5.00	8.30	16.6	84	
0.6	0.37	0.30	0.70	1.20	1.80	2.60	4.20	8.43	-	75	

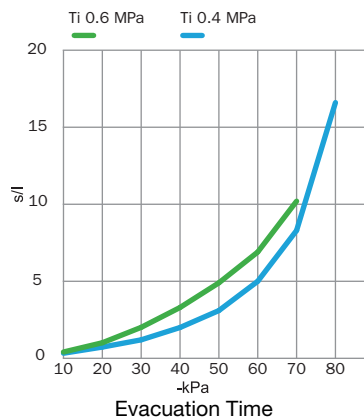
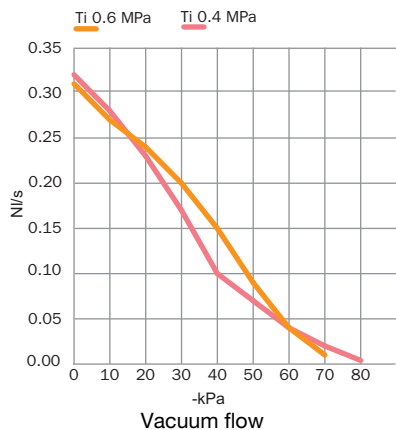

## Ordering information

	Description	Art. No.
A	COAX® cartridge MICRO Ti05-2	0123098
B	COAX® cartridge MICRO Ti05-2, holding cap	0125794

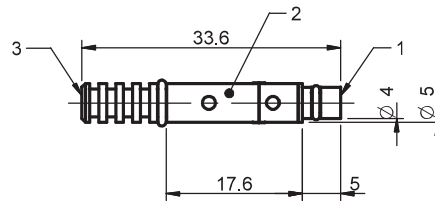
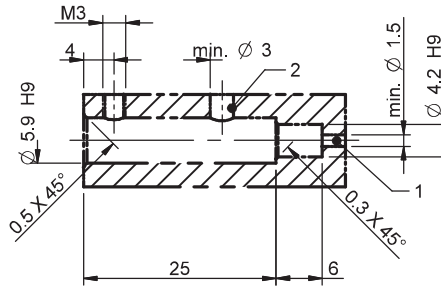
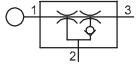

A

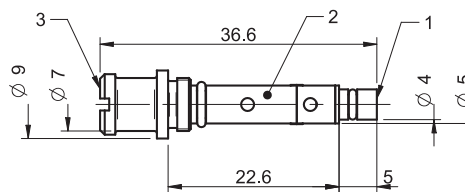
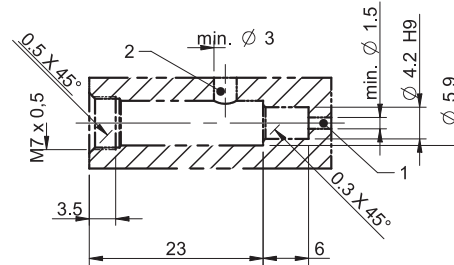
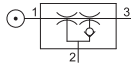

B

## Xi2.5-2



- ▶ Two-stage COAX® cartridge - MICRO - probably the world's smallest multistage vacuum ejector.
- ▶ High vacuum flow at deep vacuum levels, to 92 -kPa.
- ▶ Large vacuum flow in relation to energy consumption.
- ▶ Quick response time when deep vacuum is needed.
- ▶ Good for handling sealed materials.

### Technical data

Description	Unit	Value
Feed pressure, max.	MPa	0.7
Temperature range	°C	-10-80
Weight	g	1.5-2.3
Material		AI, NBR, PA, SS, TPE

### Vacuum flow

Feed pressure MPa	Air consumption NI/s	Vacuum flow (NI/s) at different vacuum levels (-kPa)										Max vacuum -kPa
		0	10	20	30	40	50	60	70	80		
0.45	0.12	0.23	0.15	0.08	0.05	0.04	0.03	0.02	0.01	0.003	89	
0.50	0.13	0.24	0.17	0.10	0.06	0.04	0.03	0.02	0.01	0.010	92	
0.60	0.15	0.24	0.16	0.09	0.05	0.04	0.03	0.02	0.01	0.005	91	

### Evacuation time

Feed pressure MPa	Air consumption NI/s	Evacuation time (s/l) to reach different vacuum levels (-kPa)								Max vacuum -kPa
		10	20	30	40	50	60	70	80	
0.45	0.12	0.53	1.40	2.93	5.20	8.00	12.0	18.7	34.1	89
0.50	0.13	0.49	1.23	2.48	4.50	7.30	11.3	18.0	28.0	92
0.60	0.15	0.50	1.30	2.73	5.00	7.80	11.8	18.5	31.8	91

### Blow flow

Feed pressure MPa	Air consumption NI/s	Blow flow (NI/s) at different pressure levels (kPa)										Max pressure kPa
		0	10	20	30	40	50	60	70	80		
0.6	0.15	0.37	0.33	0.26	0.21	0.21	0.20	0.19	0.17	0.15	90	

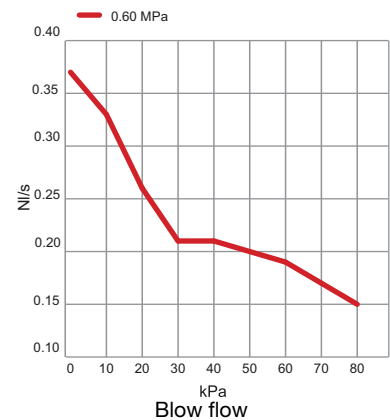
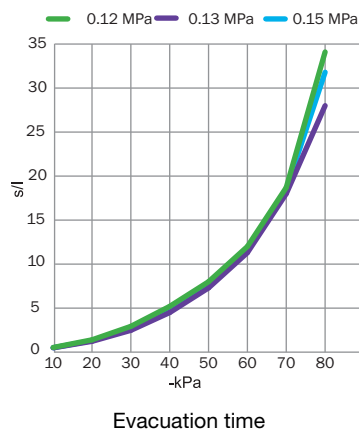
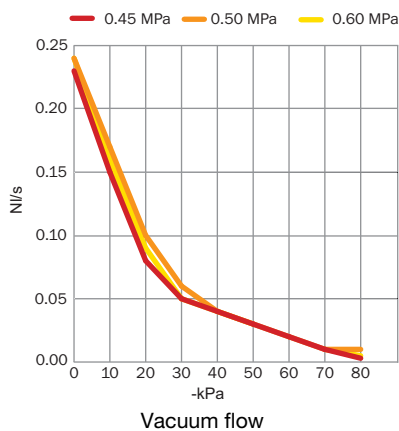

## Ordering information

	Description	Art. No.
A	COAX® cartridge MICRO Xi2.5-2	0120297
B	COAX® cartridge MICRO Xi2.5-2, holding cap	0120283

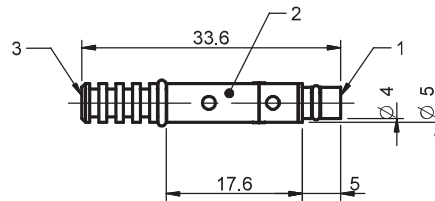
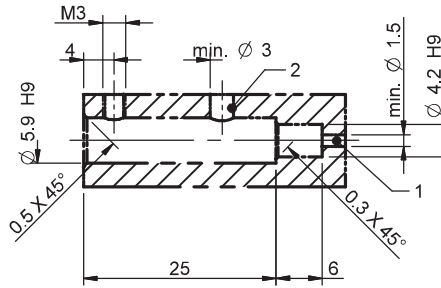
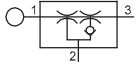

A

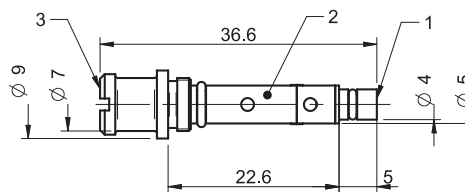
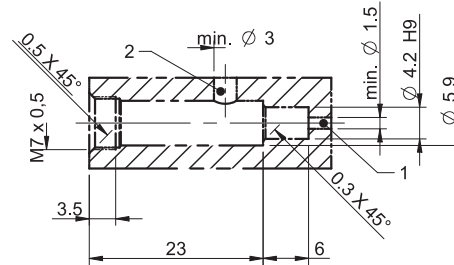
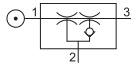

B

## Pi12-2



- ▶ Two-stage COAX® cartridge - MINI - with small mounting dimensions.
- ▶ Vacuum level to 90 -kPa at low feed pressures.
- ▶ High operational reliability in case of fluctuating or low compressed-air pressure.
- ▶ Suitable for handling sealed objects.

### Technical data

Description	Unit	Value
Feed pressure, max.	MPa	0.7
Temperature range	°C	-10-80
Weight	g	2.6-9.7
Material		Al, NBR, PA, SS

### Vacuum flow

Feed pressure MPa	Air consumption NI/s	Vacuum flow (NI/s) at different vacuum levels (-kPa)										Max vacuum -kPa
		0	10	20	30	40	50	60	70	80		
0.17	0.29	0.57	0.40	0.22	0.15	0.070	—	—	—	—	—	49
0.22	0.34	0.64	0.48	0.29	0.20	0.14	0.080	0.020	—	—	—	64
0.314	0.44	0.68	0.60	0.44	0.27	0.19	0.14	0.10	0.060	0.030	—	90
0.40	0.53	0.66	0.60	0.52	0.39	0.24	0.12	0.10	0.060	0.020	—	84

### Evacuation time

Feed pressure MPa	Air consumption NI/s	Evacuation time (s/l) to reach different vacuum levels (-kPa)										Max vacuum -kPa
		10	20	30	40	50	60	70	80			
0.17	0.29	0.28	0.56	1.13	2.13	—	—	—	—	—	49	
0.22	0.34	0.20	0.42	0.85	1.5	2.3	3.0	—	—	—	64	
0.314	0.44	0.17	0.32	0.58	1.1	1.8	2.7	4.0	6.4	—	90	
0.40	0.53	0.18	0.33	0.54	0.85	1.5	2.5	3.8	7.1	—	84	

### Blow flow

Feed pressure MPa	Air consumption NI/s	Blow flow (NI/s) at different pressure levels (kPa)													Max pressure kPa
		0	20	40	60	70	80	90	100	110	120	130	140		
0.6	0.75	1.37	1.36	1.33	1.12	1.03	1.03	1.03	1.03	1.0	0.95	0.86	0.79	140	

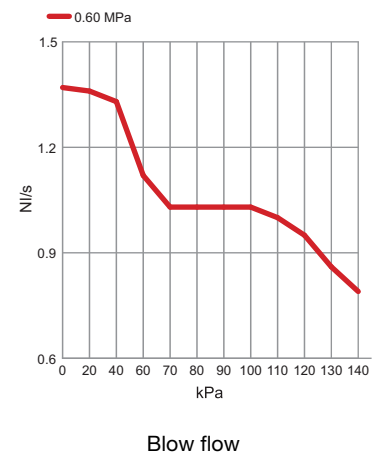
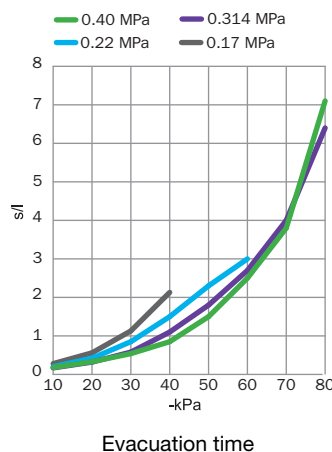
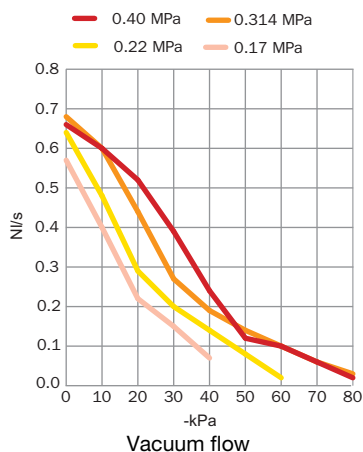

## Ordering information

	Description	Art. No.
C	COAX® cartridge MINI Pi12-2	0106922
A	COAX® cartridge MINI Pi12-2, holding cap	0106924
D	COAX® cartridge MINI Pi12-2, extra non-return valve	0106963
B	COAX® cartridge MINI Pi12-2, holding cap, extra non-return valve	0106964

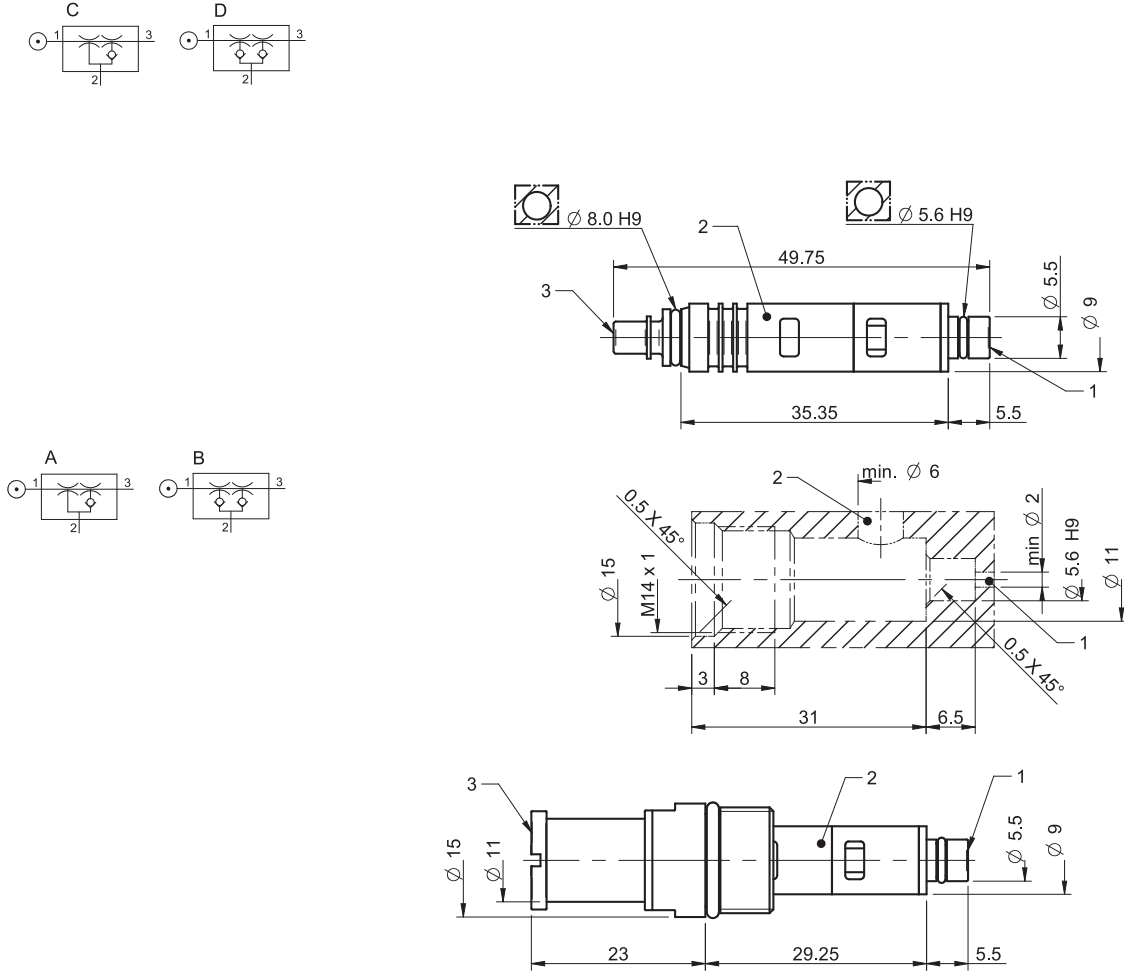

## Ordering information, accessories

Description	Art. No.
Silencer COAX® MINI	0111977

## Pi12-3



- ▶ Three-stage COAX® cartridge - MINI - with high initial vacuum flow.
- ▶ Vacuum level to 90 -kPa at low feed pressure.
- ▶ High system reliability in case of fluctuating or low feed pressure.
- ▶ Suitable for handling sealed objects with high pick-up speed.

### Technical data

Description	Unit	Value
Feed pressure, max.	MPa	0.7
Temperature range	°C	-10-80
Weight	g	4.7-12.5
Material		Al, NBR, PA, SS

### Vacuum flow

Feed pressure MPa	Air consumption NI/s	Vacuum flow (NI/s) at different vacuum levels (-kPa)										Max vacuum -kPa
		0	10	20	30	40	50	60	70	80		
0.17	0.29	0.90	0.40	0.22	0.15	0.07	—	—	—	—	—	49
0.22	0.34	1.10	0.48	0.29	0.20	0.14	0.08	0.02	—	—	—	64
0.314	0.44	1.40	0.60	0.44	0.27	0.19	0.14	0.10	0.06	0.03	—	90
0.40	0.53	1.40	0.70	0.52	0.39	0.24	0.12	0.10	0.06	0.02	—	84

### Evacuation time

Feed pressure MPa	Air consumption NI/s	Evacuation time (s/l) to reach different vacuum levels (-kPa)								Max vacuum -kPa
		10	20	30	40	50	60	70	80	
0.17	0.29	0.15	0.46	1.00	2.00	—	—	—	—	49
0.22	0.34	0.10	0.32	0.75	1.40	2.20	2.90	—	—	64
0.314	0.44	0.08	0.23	0.49	1.00	1.70	2.60	3.90	6.30	90
0.40	0.53	0.09	0.24	0.45	0.76	1.40	2.40	3.70	7.00	84

### Blow flow

Feed pressure MPa	Air consumption NI/s	Blow flow (NI/s) at different pressure levels (kPa)												Max pressure kPa
		0	20	40	60	70	80	90	100	110	120	130	140	
0.6	0.75	1.87	1.4	1.33	1.12	1.03	1.03	1.03	1.03	1.0	0.95	0.86	0.79	140

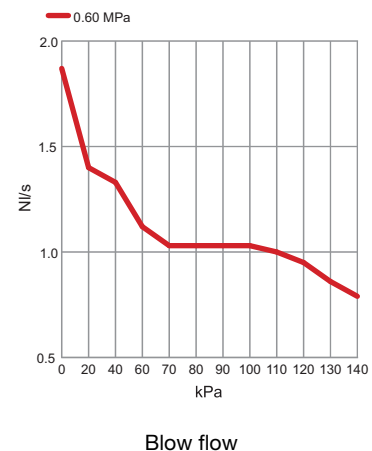
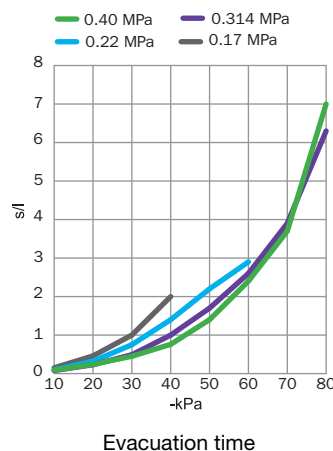
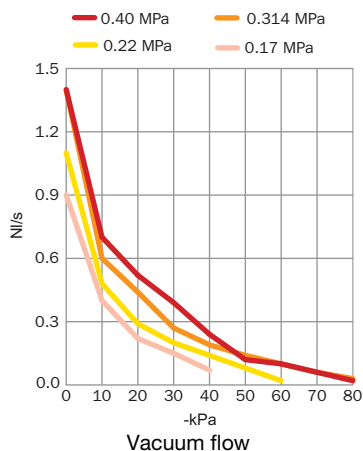



## Ordering information

	Description	Art. No.
C	COAX® cartridge MINI Pi12-3	0106895
A	COAX® cartridge MINI Pi12-3, holding cap	0106923
D	COAX® cartridge MINI Pi12-3, extra non-return valve	0106956
B	COAX® cartridge MINI Pi12-3, holding cap, extra non-return valve	0106957

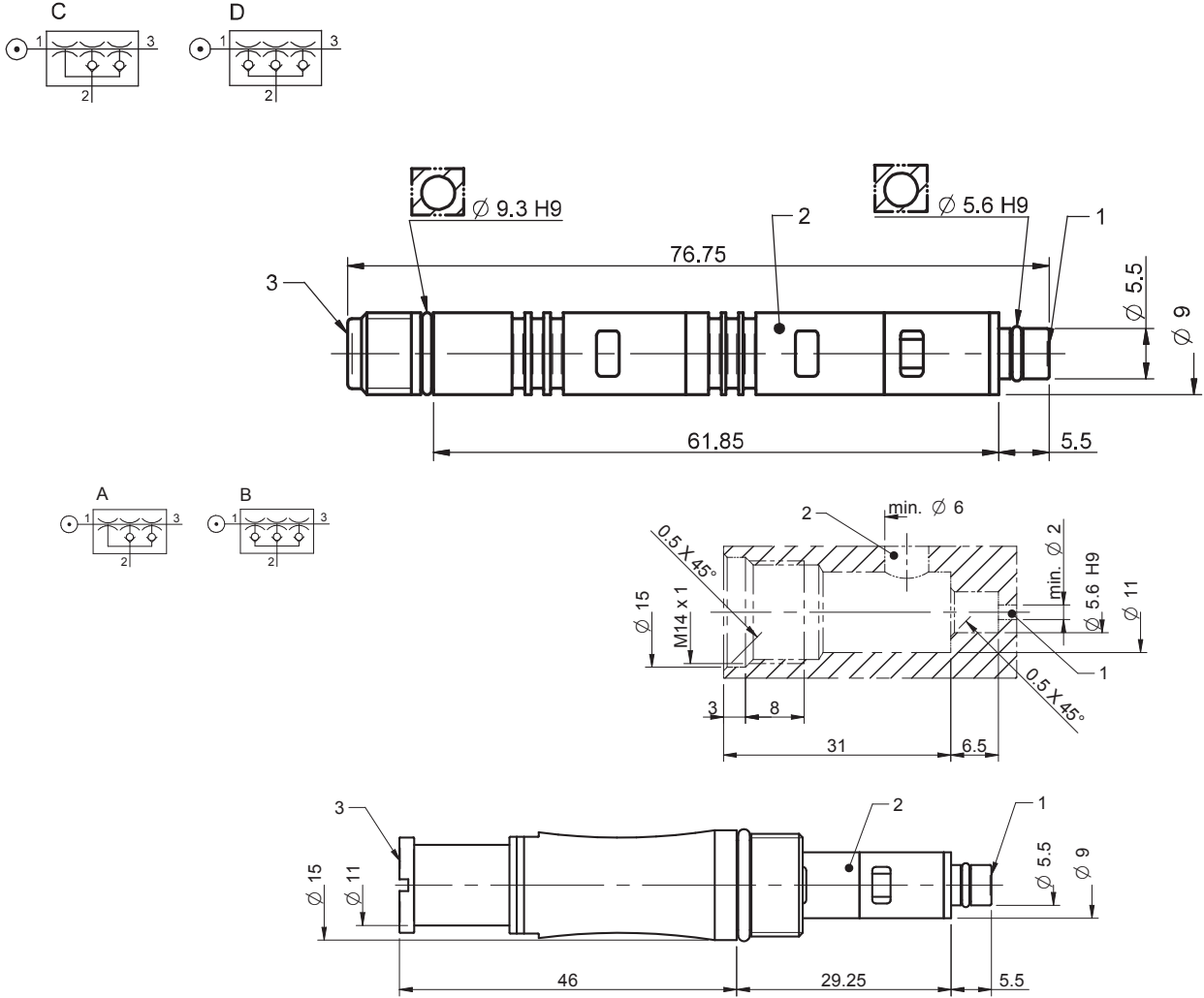

## Ordering information, accessories

Description	Art. No.
Silencer COAX® MINI	0111977
Exhaust adapter	0106344

## Pi12-3 FS



- ▶ Three-stage COAX® cartridge - MINI - with high initial vacuum flow.
- ▶ Includes a flow-through silencer and a built-in vacuum filter for harsh environments.
- ▶ Vacuum level to 90 -kPa at low feed pressure.
- ▶ High system reliability in case of fluctuating or low feed pressure.
- ▶ Suitable for handling sealed objects with high pick-up speed.

### Technical data

Description	Unit	Value
Feed pressure, max.	MPa	0.7
Temperature range	°C	-10-80
Weight	g	11.4
Material		NBR, PA, PP, SS

### Vacuum flow

Feed pressure MPa	Air consumption NI/s	Vacuum flow (NI/s) at different vacuum levels (-kPa)										Max vacuum -kPa
		0	10	20	30	40	50	60	70	80		
0.17	0.29	0.90	0.40	0.22	0.15	0.07	—	—	—	—	—	49
0.22	0.34	1.10	0.48	0.29	0.20	0.14	0.08	0.02	—	—	—	64
0.314	0.44	1.40	0.60	0.44	0.27	0.19	0.14	0.10	0.06	0.03	—	90
0.40	0.53	1.40	0.70	0.52	0.39	0.24	0.12	0.10	0.06	0.02	—	84

### Evacuation time

Feed pressure MPa	Air consumption NI/s	Evacuation time (s/l) to reach different vacuum levels (-kPa)								Max vacuum -kPa
		10	20	30	40	50	60	70	80	
0.17	0.29	0.15	0.46	1.00	2.00	—	—	—	—	49
0.22	0.34	0.10	0.32	0.75	1.40	2.20	2.90	—	—	64
0.314	0.44	0.08	0.23	0.49	1.00	1.70	2.60	3.90	6.30	90
0.40	0.53	0.09	0.24	0.45	0.76	1.40	2.40	3.70	7.00	84

### Blow flow

Feed pressure MPa	Air consumption NI/s	Blow flow (NI/s) at different pressure levels (kPa)											Max pressure kPa	
		0	20	40	60	70	80	90	100	110	120	130		140
0.6	0.75	1.87	1.4	1.33	1.12	1.03	1.03	1.03	1.03	1.0	0.95	0.86	0.79	140

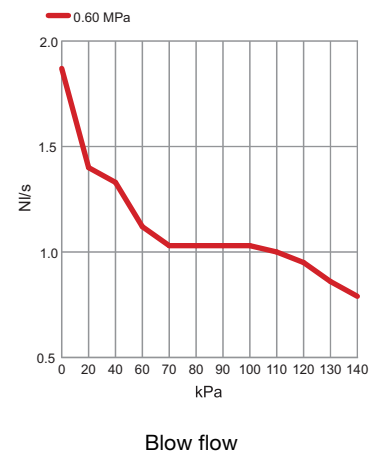
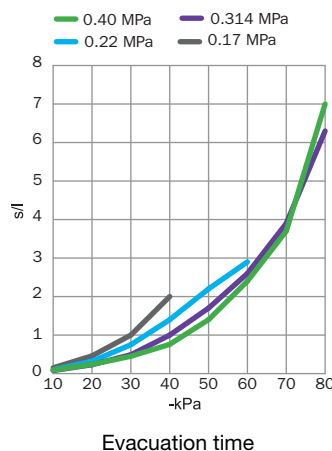
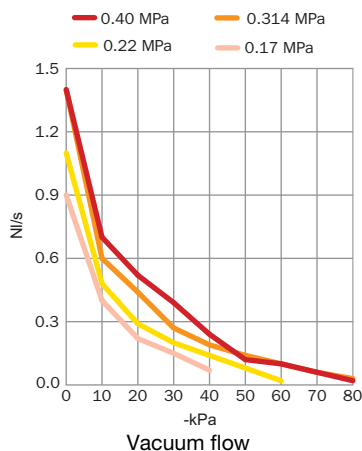

## Ordering information

	Description	Art. No.
E	COAX® cartridge MINI Pi12-3, holding cap silencer, vacuum filter	0104265
F	COAX® cartridge MINI Pi12-3, extra non-return valve, holding cap silencer, vacuum filter	0106676

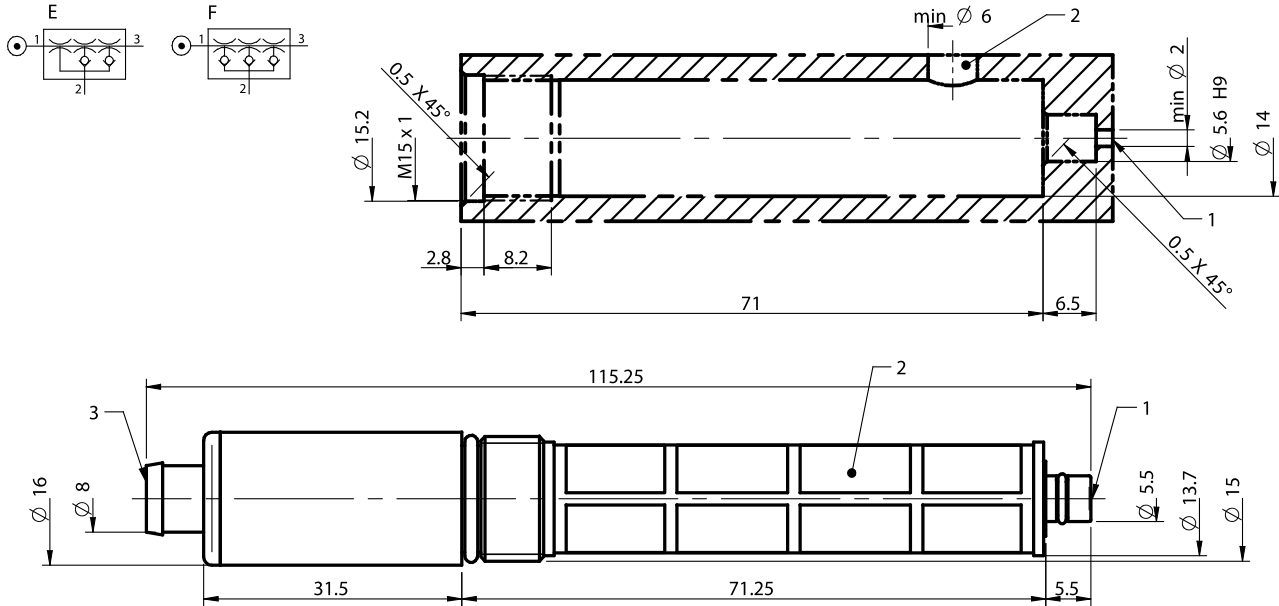

## Ordering information, accessories

Description	Art. No.
Silencer COAX® MINI	0111977
Exhaust adapter	0106344

## Si08-2



- ▶ Two-stage COAX® cartridge - MINI - with small mounting dimensions.
- ▶ Large vacuum flow in relation to energy consumption.
- ▶ Good for handling porous materials or if surface leakage is present.

### Technical data

Description	Unit	Value
Feed pressure, max.	MPa	0.7
Temperature range	°C	-10–80
Weight	g	2.8–9.9
Material		Al, NBR, PA, SS

### Vacuum flow

Feed pressure MPa	Air consumption NI/s	Vacuum flow (NI/s) at different vacuum levels (-kPa)								Max vacuum -kPa
		0	10	20	30	40	50	60	70	
0.40	0.31	0.71	0.53	0.34	0.26	0.18	0.09	0.01	—	60
0.50	0.38	0.77	0.61	0.43	0.29	0.23	0.15	0.08	0.01	70
0.60	0.44	0.77	0.67	0.51	0.33	0.23	0.16	0.12	0.08	75

### Evacuation time

Feed pressure MPa	Air consumption NI/s	Evacuation time (s/l) to reach different vacuum levels (-kPa)								Max vacuum -kPa
		10	20	30	40	50	60	70		
0.40	0.31	0.16	0.39	0.72	1.2	1.9	3.9	—	60	
0.50	0.38	0.14	0.34	0.62	1.0	1.5	2.4	4.6	70	
0.60	0.44	0.14	0.31	0.55	0.9	1.4	2.1	3.1	75	

### Blow flow

Feed pressure MPa	Air consumption NI/s	Blow flow (NI/s) at different pressure levels (kPa)								Max pressure kPa
		0	10	20	30	40	50	60	70	
0.60	0.44	1.21	1.13	1.0	0.84	0.78	0.73	0.65	0.53	70

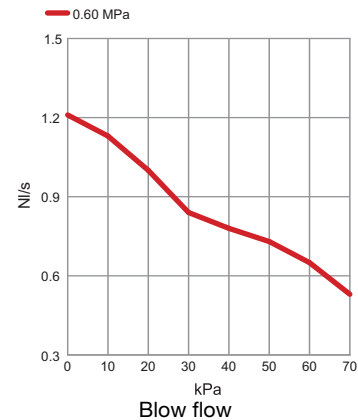
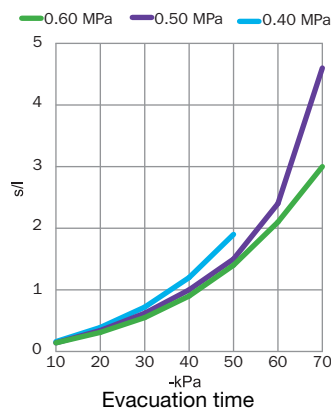
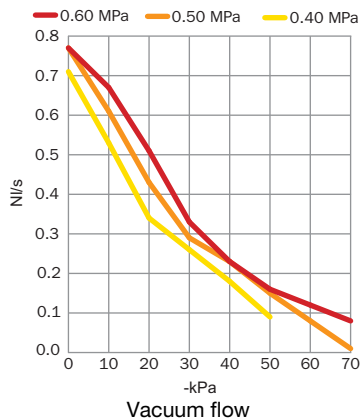

## Ordering information

	Description	Art. No.
C	COAX® cartridge MINI Si08-2	0113583
A	COAX® cartridge MINI Si08-2, holding cap	0113585
D	COAX® cartridge MINI Si08-2, extra non-return valve	0113587
B	COAX® cartridge MINI Si08-2, holding cap, extra non-return valve	0113589

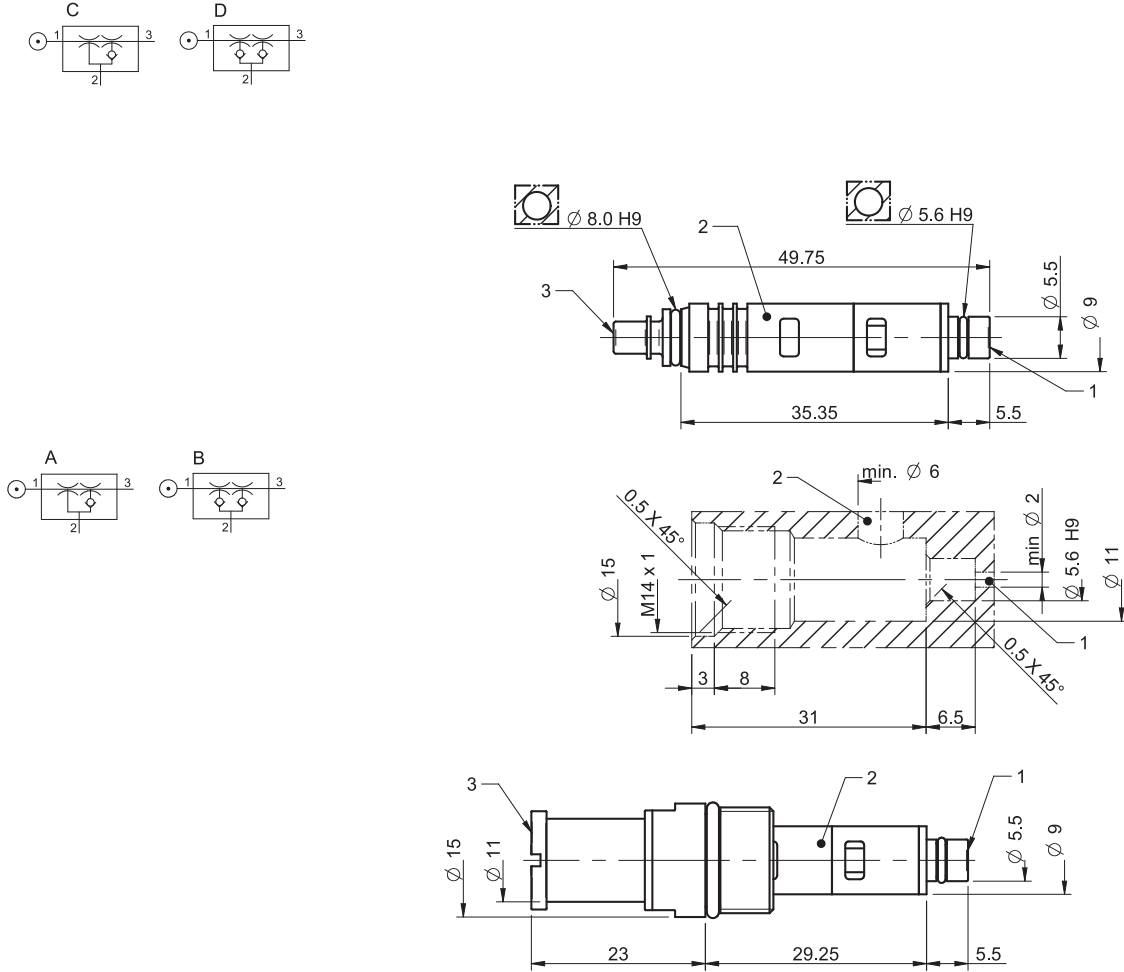

## Ordering information, accessories

Description	Art. No.
Silencer COAX® MINI	0111977

## Si08-3



- ▶ Three-stage COAX® cartridge - MINI - with extra high initial vacuum flow.
- ▶ Large vacuum flow in relation to energy consumption.
- ▶ Good for handling porous materials or if surface leakage is present. Recommended for high speed applications.

### Technical data

Description	Unit	Value
Feed pressure, max.	MPa	0.7
Temperature range	°C	-10-80
Weight	g	4.9-12.7
Material		Al, NBR, PA, SS

### Vacuum flow

Feed pressure MPa	Air consumption NI/s	Vacuum flow (NI/s) at different vacuum levels (-kPa)								Max vacuum -kPa
		0	10	20	30	40	50	60	70	
0.40	0.31	1.10	0.57	0.36	0.26	0.18	0.09	—	—	60
0.50	0.38	1.23	0.65	0.46	0.29	0.23	0.15	0.08	0.01	70
0.60	0.44	1.34	0.73	0.55	0.35	0.23	0.17	0.13	0.08	75

### Evacuation time

Feed pressure MPa	Air consumption NI/s	Evacuation time (s/l) to reach different vacuum levels (-kPa)							Max vacuum -kPa
		10	20	30	40	50	60	70	
0.40	0.31	0.12	0.33	0.66	1.10	1.90	—	—	60
0.50	0.38	0.11	0.29	0.55	0.90	1.50	2.30	4.60	70
0.60	0.44	0.10	0.25	0.48	0.80	1.30	2.00	2.90	75

### Blow flow

Feed pressure MPa	Air consumption NI/s	Blow flow (NI/s) at different pressure levels (kPa)								Max pressure kPa
		0	10	20	30	40	50	60	70	
0.60	0.44	1.78	1.16	1.03	0.86	0.80	0.75	0.66	0.53	70

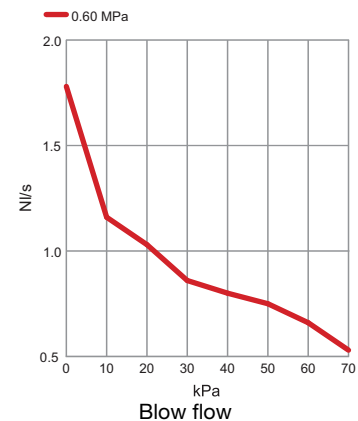
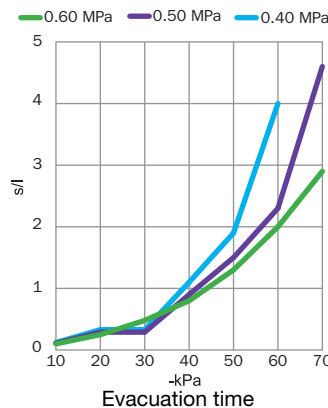
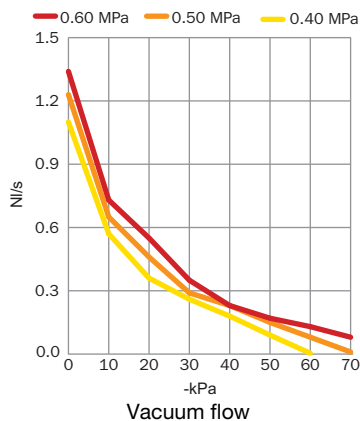

## Ordering information

	Description	Art. No.
C	COAX® cartridge MINI Si08-3	0113214
A	COAX® cartridge MINI Si08-3, holding cap	0113572
D	COAX® cartridge MINI Si08-3, extra non-return valve	0113575
B	COAX® cartridge MINI Si08-3, holding cap, extra non-return valve	0113577

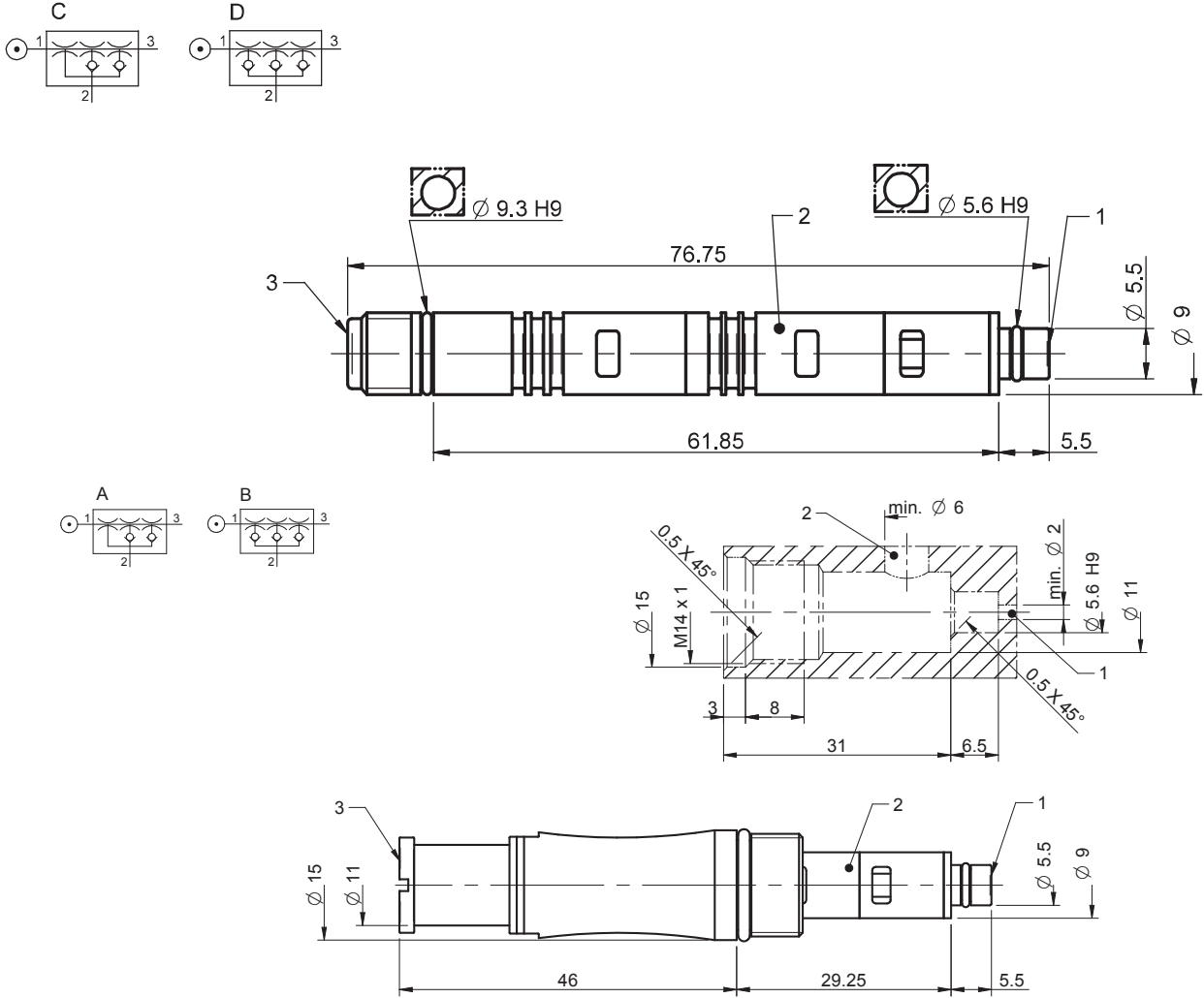

## Ordering information, accessories

Description	Art. No.
Silencer COAX® MINI	0111977
Exhaust adapter	0106344

## Si08-3 FS



- ▶ Three-stage COAX® cartridge - MINI - with extra high initial vacuum flow.
- ▶ Includes a flow-through silencer and a built-in vacuum filter for harsh environments.
- ▶ Large vacuum flow in relation to energy consumption.
- ▶ Good for handling porous materials or if leakage is present. Recommended for high speed applications.

### Technical data

Description	Unit	Value
Feed pressure, max.	MPa	0.7
Temperature range	°C	-10-80
Weight	g	11.4
Material		NBR, PA, PP, SS

### Vacuum flow

Feed pressure MPa	Air consumption NI/s	Vacuum flow (NI/s) at different vacuum levels (-kPa)								Max vacuum -kPa
		0	10	20	30	40	50	60	70	
0.40	0.31	1.10	0.57	0.36	0.26	0.18	0.09	—	—	60
0.50	0.38	1.23	0.65	0.46	0.29	0.23	0.15	0.08	0.01	70
0.60	0.44	1.34	0.73	0.55	0.35	0.23	0.17	0.13	0.08	75

### Evacuation time

Feed pressure MPa	Air consumption NI/s	Evacuation time (s/l) to reach different vacuum levels (-kPa)							Max vacuum -kPa
		10	20	30	40	50	60	70	
0.40	0.31	0.12	0.33	0.66	1.10	1.90	—	—	60
0.50	0.38	0.11	0.29	0.55	0.90	1.50	2.30	4.60	70
0.60	0.44	0.10	0.25	0.48	0.80	1.30	2.00	2.90	75

### Blow flow

Feed pressure MPa	Air consumption NI/s	Blow flow (NI/s) at different pressure levels (kPa)								Max pressure kPa
		0	10	20	30	40	50	60	70	
0.60	0.44	1.78	1.16	1.03	0.86	0.80	0.75	0.66	0.53	70

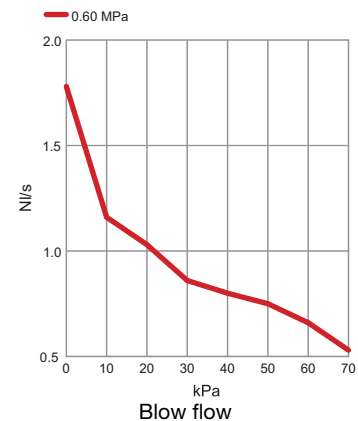
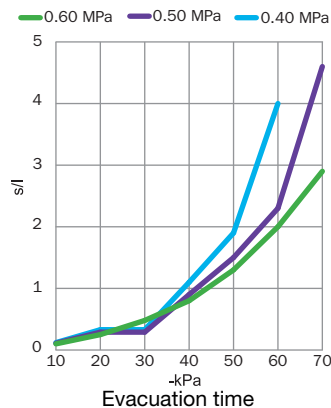
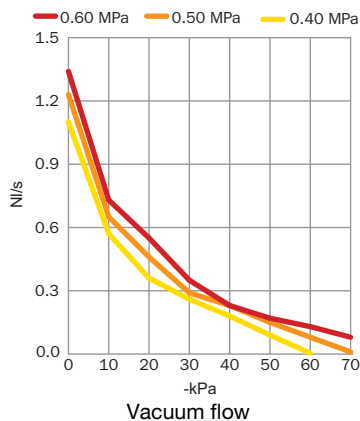



## Ordering information

	Description	Art. No.
E	COAX® cartridge MINI Si08-3, holding cap silencer, vacuum filter	0113579
F	COAX® cartridge MINI Si08-3, extra non-return valve, holding cap silencer, vacuum filter	0113581

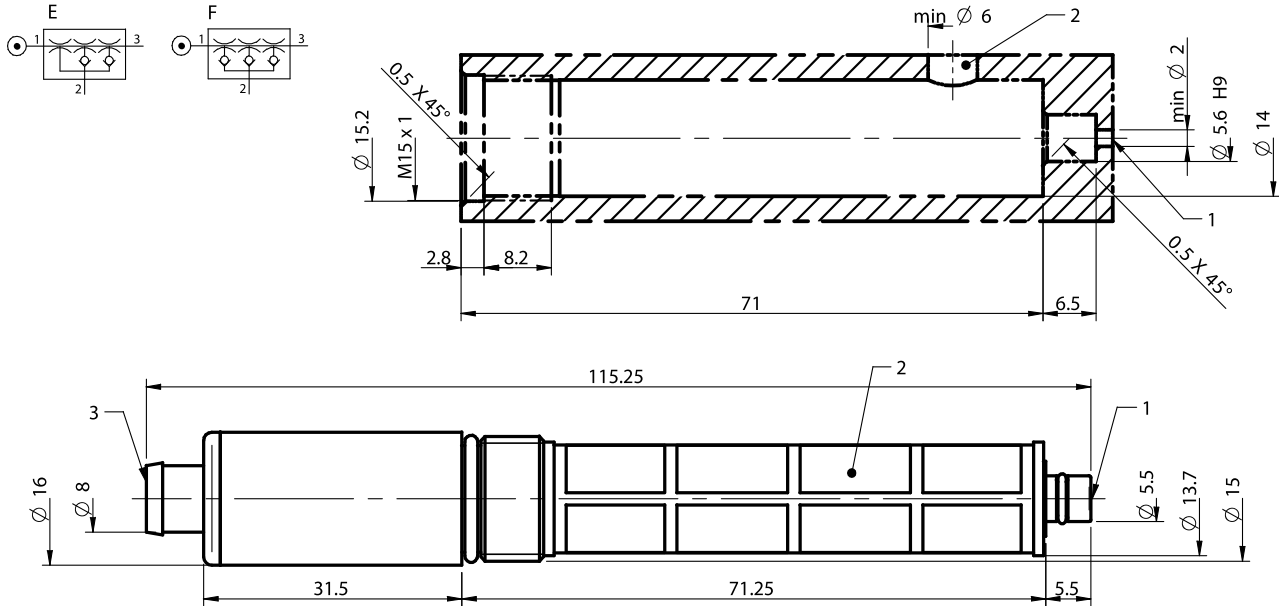

## Ordering information, accessories

Description	Art. No.
Silencer COAX® MINI	0111977
Exhaust adapter	0106344

## Xi10-2



- ▶ Two-stage COAX® cartridge - MINI - with small mounting dimensions.
- ▶ High vacuum flow at deep vacuum levels to 94 -kPa.
- ▶ Large vacuum flow in relation to energy consumption.
- ▶ Quick response time when deep vacuum is needed.
- ▶ Good for handling sealed materials.

### Technical data

Description	Unit	Value
Feed pressure, max.	MPa	0.7
Temperature range	°C	-10-80
Weight	g	2.6-9.7
Material		Al, NBR, PA, SS

### Vacuum flow

Feed pressure MPa	Air consumption NI/s	Vacuum flow (NI/s) at different vacuum levels (-kPa)										Max vacuum -kPa
		0	10	20	30	40	50	60	70	80	90	
0.45	0.42	0.75	0.61	0.45	0.28	0.19	0.15	0.11	0.07	0.043	0.003	92
0.5	0.46	0.75	0.63	0.49	0.33	0.19	0.15	0.11	0.07	0.045	0.011	94
0.6	0.54	0.74	0.63	0.53	0.42	0.30	0.16	0.11	0.08	0.041	0.010	93

### Evacuation time

Feed pressure MPa	Air consumption NI/s	Evacuation time (s/l) to reach different vacuum levels (-kPa)										Max vacuum -kPa
		10	20	30	40	50	60	70	80	90		
0.45	0.42	0.15	0.3	0.6	1.1	1.6	2.3	3.5	5.3	9.6	92	
0.5	0.46	0.14	0.3	0.6	1.0	1.6	2.3	3.5	5.3	8.9	94	
0.6	0.54	0.15	0.3	0.5	0.8	1.3	2.0	3.1	4.8	8.7	93	

### Blow flow

Feed pressure MPa	Air consumption NI/s	Blow flow (NI/s) at different pressure levels (kPa)										Max pressure kPa
		0	10	20	30	40	50	60	70	80		
0.6	0.54	1.2	1.2	1.1	0.98	0.85	0.84	0.79	0.71	0.61	90	

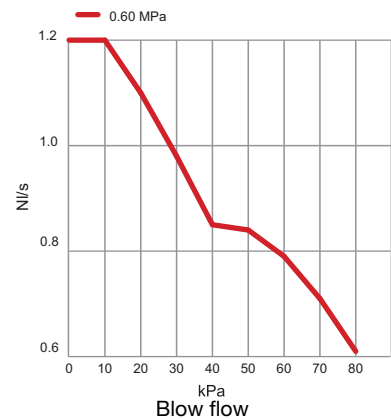
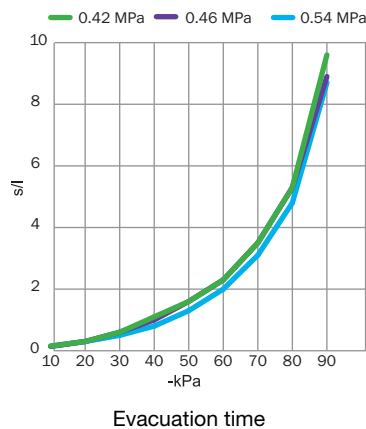
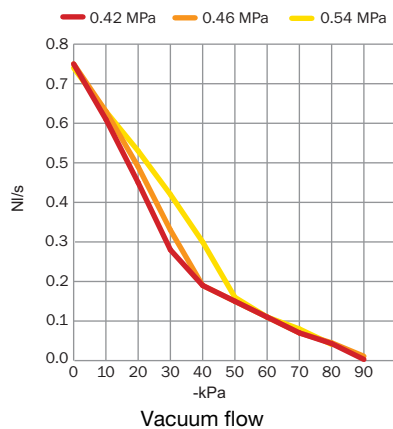

## Ordering information

	Description	Art. No.
C	COAX® cartridge MINI Xi10-2	0120284
A	COAX® cartridge MINI Xi10-2, holding cap	0120294
D	COAX® cartridge MINI Xi10-2, extra non-return valve	0120280
B	COAX® cartridge MINI Xi10-2, holding cap, extra non-return valve	0120300

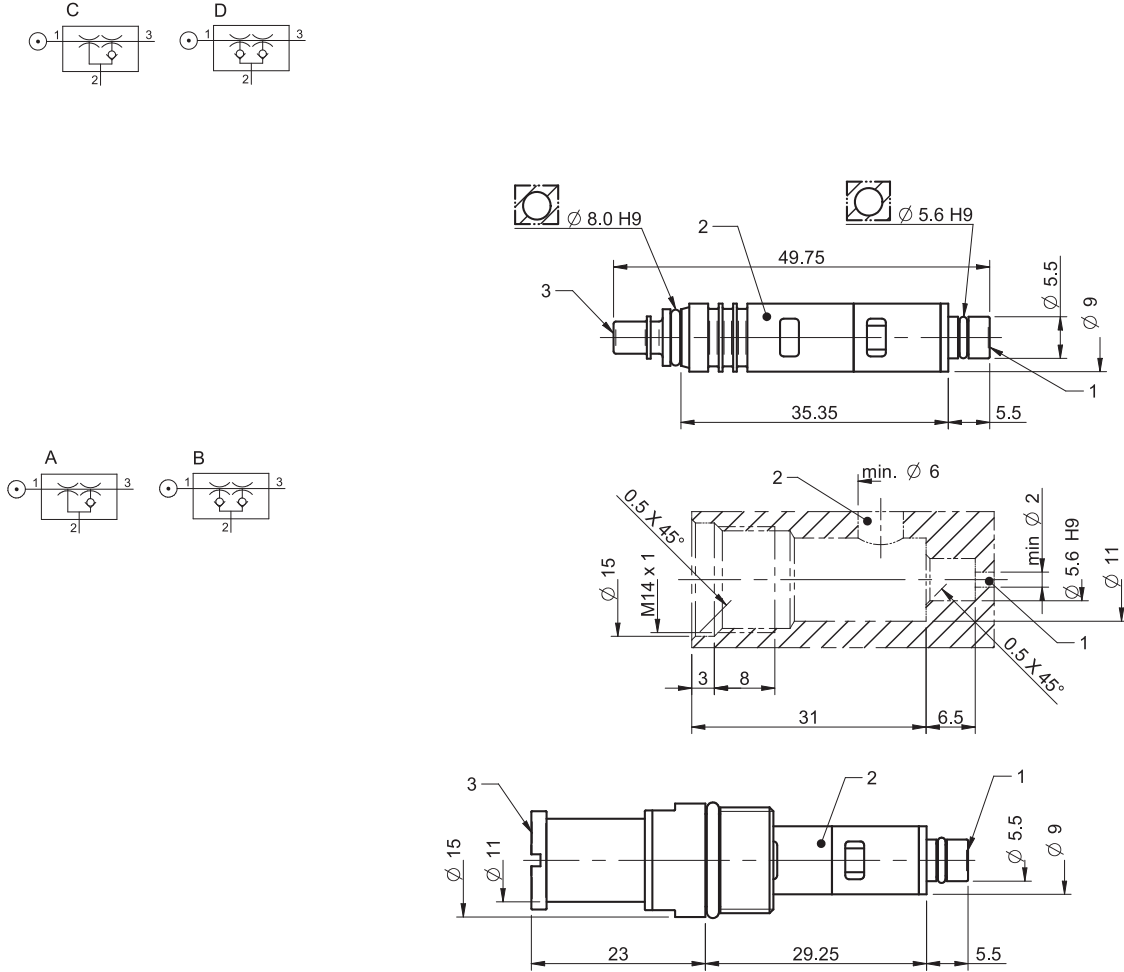

## Ordering information, accessories

Description	Art. No.
Silencer COAX® MINI	0111977

## Xi10-3



- ▶ Three-stage COAX® cartridge – MINI.
- ▶ High vacuum flow at deep vacuum levels to 94 -kPa.
- ▶ Quick response time when deep vacuum is needed.
- ▶ Suitable for handling sealed objects with high pick-up speed.
- ▶ Large vacuum flow in relation to energy consumption

### Technical data

Description	Unit	Value
Feed pressure, max.	MPa	0.7
Temperature range	°C	-10-80
Weight	g	4.7-12.5
Material		Al, NBR, PA, SS

### Vacuum flow

Feed pressure MPa	Air consumption NI/s	Vacuum flow (NI/s) at different vacuum levels (-kPa)											Max vacuum -kPa
		0	10	20	30	40	50	60	70	80	90		
0.45	0.42	1.39	0.64	0.46	0.28	0.19	0.15	0.11	0.07	0.043	0.003	92	
0.5	0.46	1.43	0.70	0.50	0.33	0.19	0.15	0.11	0.07	0.045	0.011	94	
0.6	0.54	1.45	0.79	0.53	0.42	0.30	0.16	0.11	0.08	0.041	0.010	93	

### Evacuation time

Feed pressure MPa	Air consumption NI/s	Evacuation time (s/l) to reach different vacuum levels (-kPa)										Max vacuum -kPa
		10	20	30	40	50	60	70	80	90		
0.45	0.42	0.1	0.28	0.55	1.0	1.5	2.2	3.4	5.2	9.5	92	
0.5	0.46	0.09	0.26	0.50	0.90	1.5	2.2	3.4	5.2	8.8	94	
0.6	0.54	0.09	0.24	0.45	0.70	1.2	1.9	3.0	4.7	8.6	93	

### Blow flow

Feed pressure MPa	Air consumption NI/s	Blow flow (NI/s) at different pressure levels (kPa)										Max pressure kPa
		0	10	20	30	40	50	60	70	80		
0.6	0.54	1.8	1.3	1.1	0.98	0.85	0.84	0.79	0.71	0.61	90	

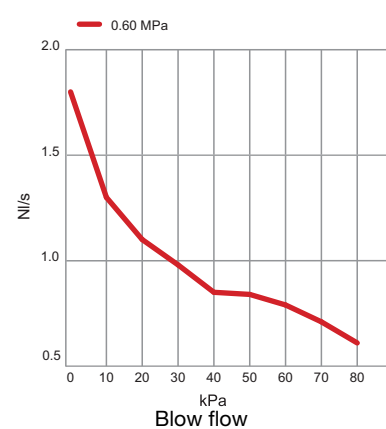
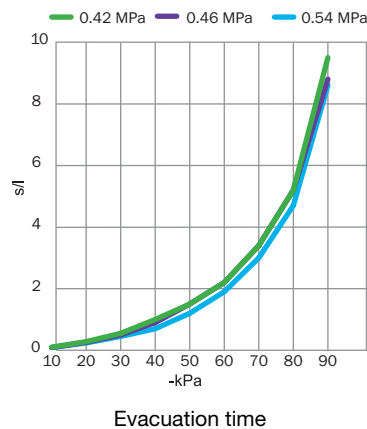
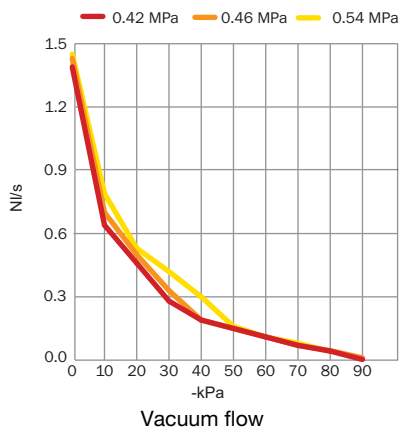

## Ordering information

	Description	Art. No.
C	COAX® cartridge MINI Xi10-3	0120286
A	COAX® cartridge MINI Xi10-3, holding cap	0120299
D	COAX® cartridge MINI Xi10-3, extra non-return valve	0120289
B	COAX® cartridge MINI Xi10-3, holding cap, extra non-return valve	0120298

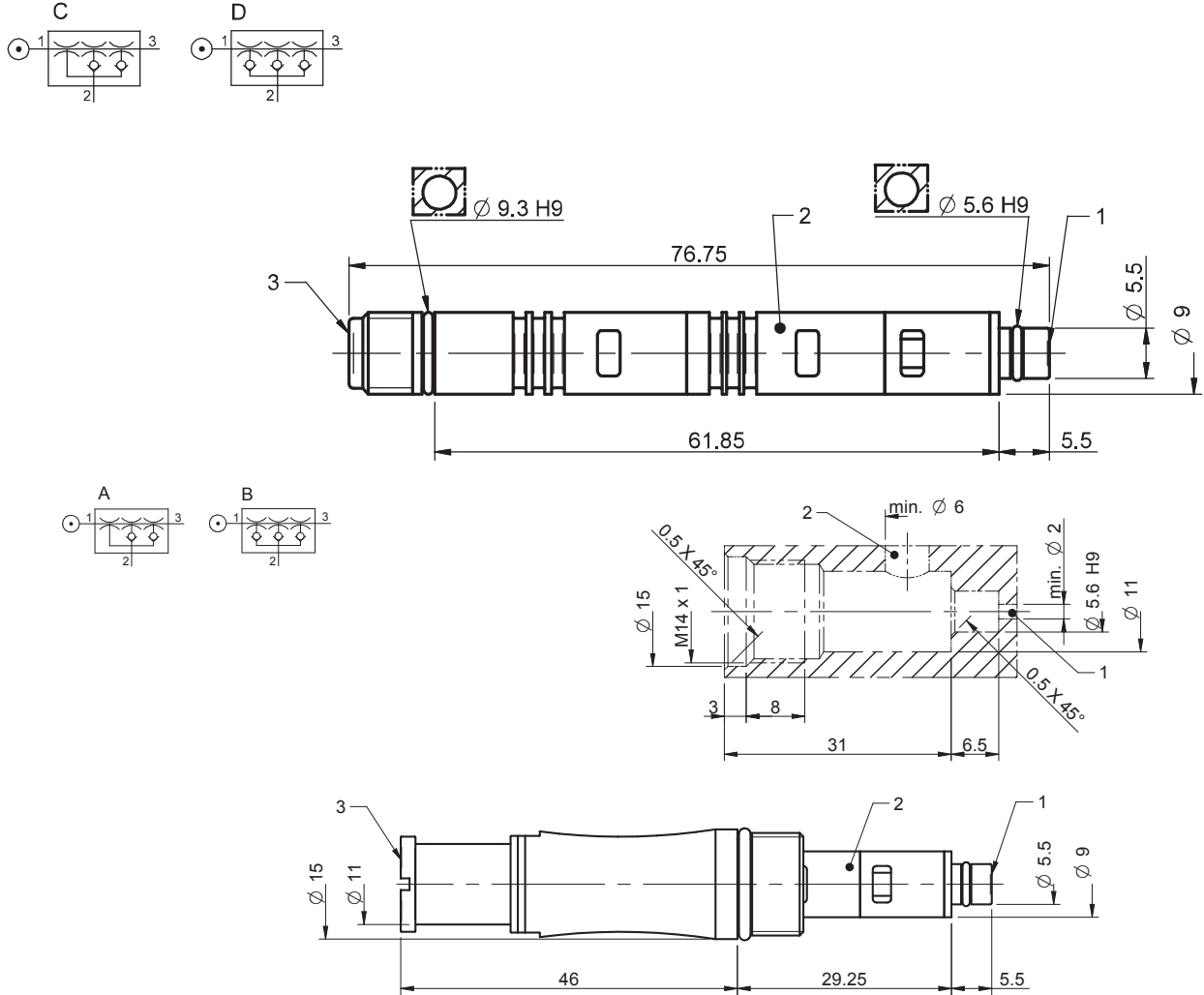

## Ordering information, accessories

Description	Art. No.
Silencer COAX® MINI	0111977

## Xi10-3 FS



- ▶ Three-stage COAX® cartridge - MINI.
- ▶ Includes a flow-through silencer and a built-in vacuum filter for harsh environments.
- ▶ High vacuum flow at deep vacuum levels to 94 - kPa.
- ▶ Quick response time when deep vacuum is needed.
- ▶ Suitable for handling sealed objects with high pick-up speed.
- ▶ Large vacuum flow in relation to energy consumption.

### Technical data

Description	Unit	Value
Feed pressure, max.	MPa	0.7
Temperature range	°C	-10-80
Weight	g	12.5
Material		NBR, PA, PP, SS

### Vacuum flow

Feed pressure MPa	Air consumption NI/s	Vacuum flow (NI/s) at different vacuum levels (-kPa)										Max vacuum -kPa
		0	10	20	30	40	50	60	70	80	90	
0.45	0.42	1.39	0.64	0.46	0.28	0.19	0.15	0.11	0.07	0.043	0.003	92
0.5	0.46	1.43	0.70	0.50	0.33	0.19	0.15	0.11	0.07	0.045	0.011	94
0.6	0.54	1.45	0.79	0.53	0.42	0.30	0.16	0.11	0.08	0.041	0.010	93

### Evacuation time

Feed pressure MPa	Air consumption NI/s	Evacuation time (s/l) to reach different vacuum levels (-kPa)										Max vacuum -kPa
		10	20	30	40	50	60	70	80	90		
0.45	0.42	0.1	0.28	0.55	1.0	1.5	2.2	3.4	5.2	9.5	92	
0.5	0.46	0.09	0.26	0.50	0.90	1.5	2.2	3.4	5.2	8.8	94	
0.6	0.54	0.09	0.24	0.45	0.70	1.2	1.9	3.0	4.7	8.6	93	

### Blow flow

Feed pressure MPa	Air consumption NI/s	Blow flow (NI/s) at different pressure levels (kPa)										Max pressure kPa
		0	10	20	30	40	50	60	70	80		
0.6	0.54	1.8	1.3	1.1	0.98	0.85	0.84	0.79	0.71	0.61	90	

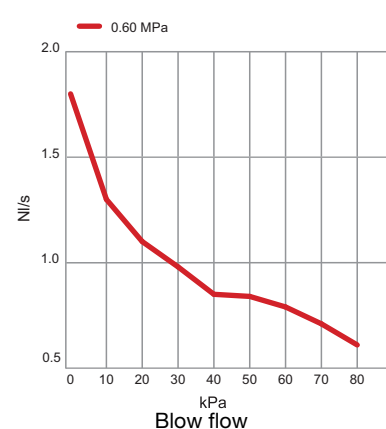
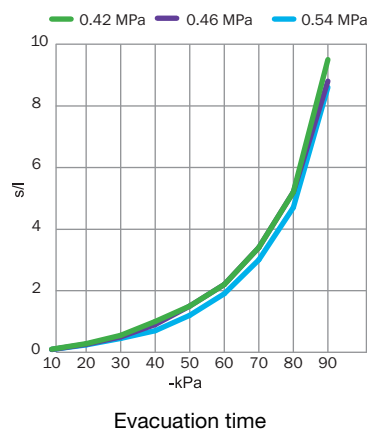
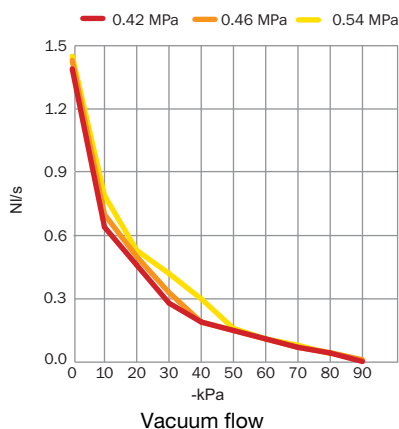

## Ordering information

	Description	Art. No.
E	COAX® cartridge MINI Xi10-3, holding cap silencer, vacuum filter	0120775
F	COAX® cartridge MINI Xi10-3, extra non-return valve, holding cap silencer, vacuum filter	0120776

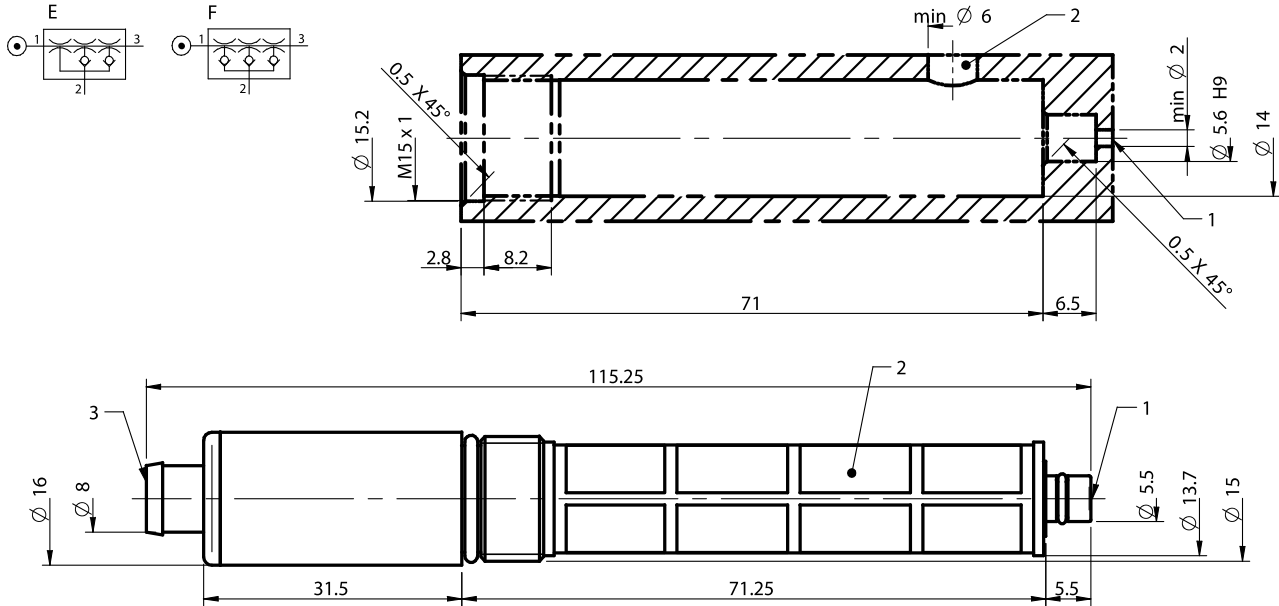

## Ordering information, accessories

Description	Art. No.
Silencer COAX® MINI	0111977
Exhaust adapter	0106344

## Pi48-2



- ▶ Two-stage COAX® cartridge - MIDI - with small mounting dimension for limited spaces.
- ▶ Vacuum level to 90 -kPa at low feed pressure.
- ▶ High system reliability in case of fluctuating or low feed pressure.
- ▶ Efficient generator of blow-air, recommended for overpressures between 0.05 and 0.14 MPa.

### Technical data

Description	Unit	Value
Feed pressure, max.	MPa	0.7
Temperature range	°C	-10-80
Weight	g	27-57
Material		Al, NBR, PA, SS

### Vacuum flow

Feed pressure MPa	Air consumption NI/s	Vacuum flow (NI/s) at different vacuum levels (-kPa)										Max vacuum -kPa
		0	10	20	30	40	50	60	70	80		
0.17	1.37	2.6	1.7	1.2	0.70	0.40	0.12	—	—	—	55	
0.22	1.62	2.7	2.0	1.5	0.90	0.55	0.45	0.26	0.07	—	73	
0.30	2.0	2.8	2.5	1.8	1.1	0.65	0.50	0.35	0.25	0.1	90	
0.40	2.54	2.8	2.5	2.1	1.5	1.1	0.66	0.36	0.26	0.08	86	

### Evacuation time

Feed pressure MPa	Air consumption NI/s	Evacuation time (s/l) to reach different vacuum levels (-kPa)										Max vacuum -kPa
		10	20	30	40	50	60	70	80	90		
0.17	1.37	0.040	0.10	0.20	0.40	1.0	—	—	—	—	55	
0.22	1.62	0.035	0.090	0.18	0.32	0.51	0.80	1.7	—	—	73	
0.30	2.0	0.030	0.070	0.13	0.26	0.46	0.70	1.0	1.6	4.0	90	
0.40	2.54	0.030	0.065	0.12	0.19	0.30	0.60	0.90	1.7	4.5	86	

### Blow flow

Feed pressure MPa	Air consumption NI/s	Blow flow (NI/s) at different pressure levels (kPa)												Max pressure kPa
		0	20	40	60	70	80	90	100	110	120	130	140	
0.6	3.5	6.15	6.15	5.95	5.03	4.49	4.49	4.49	4.49	4.49	4.26	4.0	3.63	140

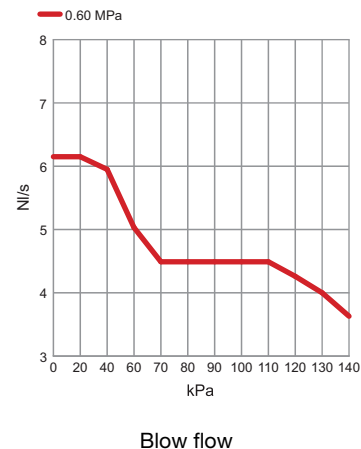
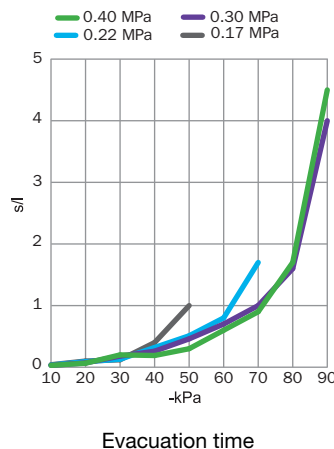
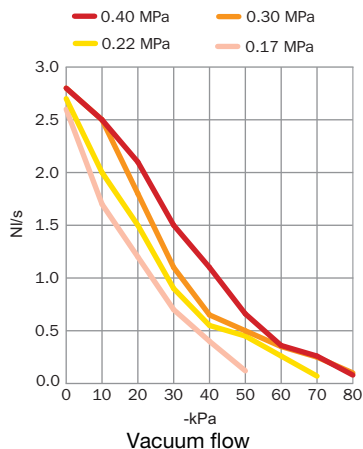



## Ordering information

	Description	Art. No.
C	COAX® cartridge MIDI Pi48-2	0107125
A	COAX® cartridge MIDI Pi48-2, holding cap	0107127
D	COAX® cartridge MIDI Pi48-2, extra non-return valve	0107710
B	COAX® cartridge MIDI Pi48-2, holding cap, extra non-return valve	0107712

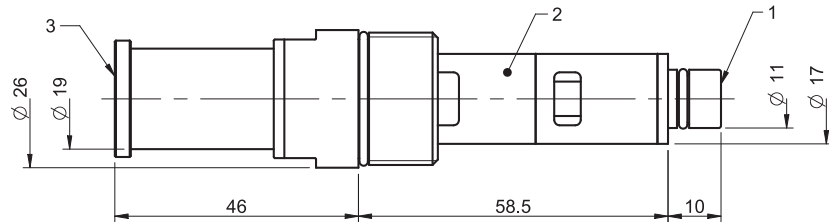
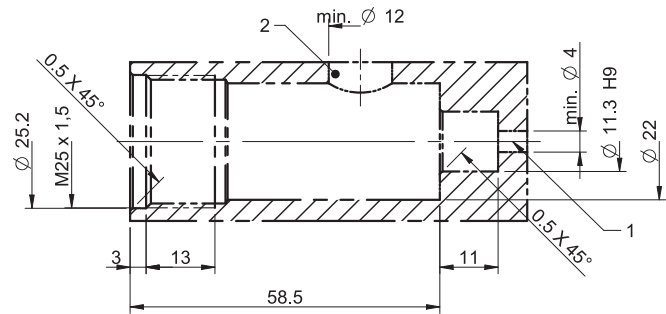
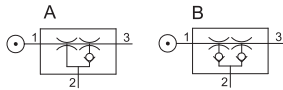
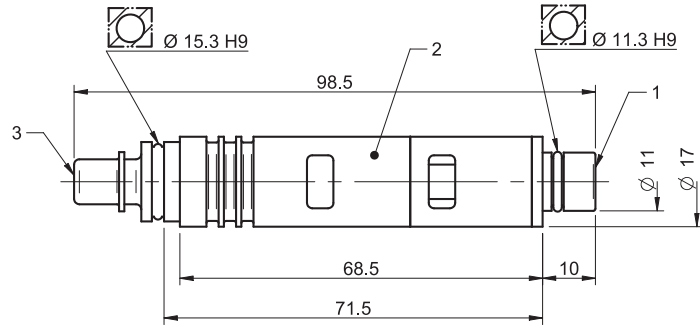
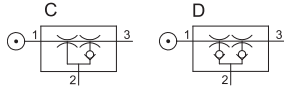

## Ordering information, accessories

Description	Art. No.
Silencer COAX® MIDI	0111976

## Pi48-3



- ▶ Three-stage COAX® cartridge - MIDI - with high initial vacuum flow.
- ▶ Vacuum level to 90 -kPa at low feed pressure.
- ▶ High system reliability in case of fluctuating or low feed pressure.
- ▶ Suitable for fast evacuation of large volumes in sealed systems.
- ▶ Efficient generator of blow-air. Recommended for overpressures between 0.05 and 0.14 MPa.

### Technical data

Description	Unit	Value
Feed pressure, max.	MPa	0.7
Temperature range	°C	-10-80
Weight	g	33-70
Material		Al, NBR, PA, SS

### Vacuum flow

Feed pressure MPa	Air consumption NI/s	Vacuum flow (NI/s) at different vacuum levels (-kPa)										Max vacuum -kPa
		0	10	20	30	40	50	60	70	80	90	
0.17	1.37	4.0	1.7	1.2	0.70	0.40	0.12	—	—	—	—	55
0.22	1.62	5.0	2.0	1.5	0.90	0.55	0.45	0.26	0.07	—	—	73
0.30	2.0	5.6	2.5	1.8	1.1	0.65	0.50	0.35	0.25	0.10	—	90
0.40	2.54	5.7	2.5	2.1	1.5	1.1	0.66	0.36	0.26	0.08	—	86

### Evacuation time

Feed pressure MPa	Air consumption NI/s	Evacuation time (s/l) to reach different vacuum levels (-kPa)										Max vacuum -kPa
		10	20	30	40	50	60	70	80	90	90	
0.17	1.37	0.030	0.10	0.20	0.40	1.0	—	—	—	—	—	55
0.22	1.62	0.025	0.080	0.17	0.30	0.50	0.80	1.7	—	—	—	73
0.30	2.0	0.020	0.060	0.12	0.25	0.45	0.70	1.0	1.6	4.0	—	90
0.40	2.54	0.020	0.055	0.11	0.18	0.29	0.59	0.90	1.7	4.5	—	86

### Blow flow

Feed pressure MPa	Air consumption NI/s	Blow flow (NI/s) at different pressure levels (kPa)												Max pressure kPa
		0	20	40	60	70	80	90	100	110	120	130	140	
0.60	3.5	9.5	6.5	6.0	5.3	4.7	4.6	4.6	4.6	4.5	4.3	4.0	3.7	140

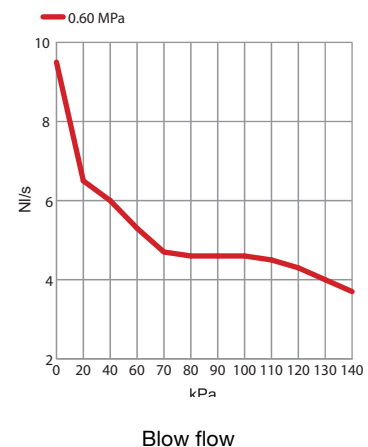
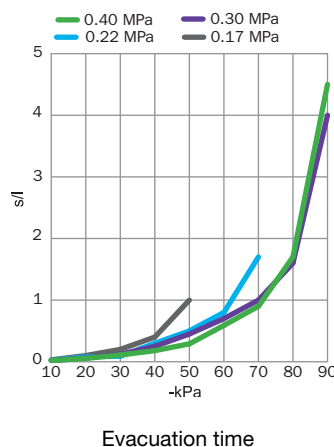
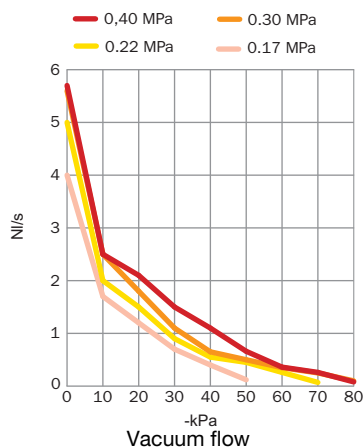



## Si32-2



- ▶ Two-stage COAX® cartridge - MIDI - with small mounting dimension for limited spaces.
- ▶ Large vacuum flow in relation to energy consumption.
- ▶ Suitable for high-volume evacuation when handling porous materials or if surface leakage is present.
- ▶ Efficient generator of blow-air. Recommended for low overpressures (0 - 0.05 MPa).

### Technical data

Description	Unit	Value
Feed pressure, max.	MPa	0.7
Temperature range	°C	-10-80
Weight	g	27-57
Material		Al, NBR, PA, SS

### Vacuum flow

Feed pressure MPa	Air consumption NI/s	Vacuum flow (NI/s) at different vacuum levels (-kPa)								Max vacuum -kPa
		0	10	20	30	40	50	60	70	
0.40	1.25	3.1	2.6	1.9	1.2	0.80	0.40	0.1	—	60
0.50	1.50	3.2	2.9	2.2	1.4	0.85	0.62	0.35	0.18	70
0.60	1.75	3.3	3.0	2.6	1.7	0.90	0.60	0.50	0.35	75

### Evacuation time

Feed pressure MPa	Air consumption NI/s	Evacuation time (s/l) to reach different vacuum levels (-kPa)							Max vacuum -kPa
		10	20	30	40	50	60	70	
0.40	1.25	0.040	0.080	0.14	0.24	0.42	1.0	—	60
0.50	1.50	0.030	0.070	0.11	0.21	0.35	0.60	1.0	70
0.60	1.75	0.030	0.070	0.10	0.18	0.33	0.53	0.80	75

### Blow flow

Feed pressure MPa	Air consumption NI/s	Blow flow (NI/s) at different pressure levels (kPa)										Max pressure kPa
		0	10	20	30	40	50	60	70	80		
0.6	1.75	5.05	4.83	4.25	3.61	3.30	2.89	2.65	2.35	1.97	80	

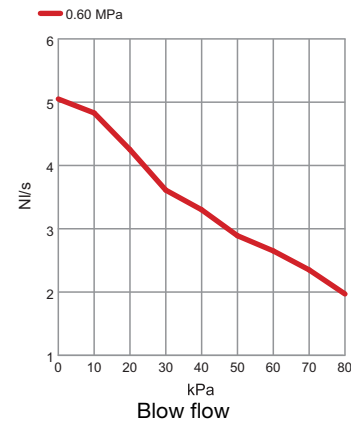
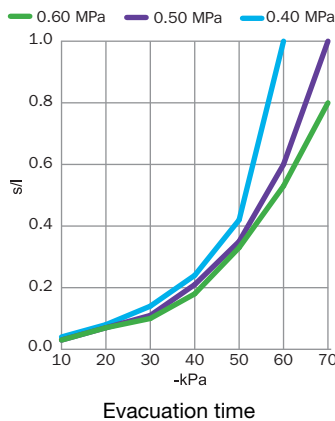
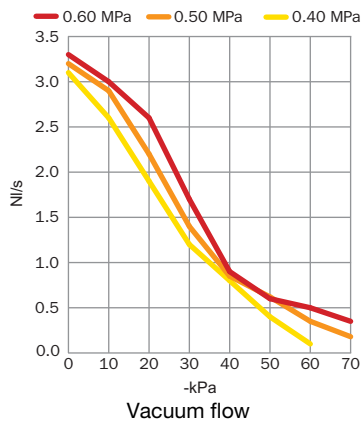

## Ordering information

	Description	Art. No.
C	COAX® cartridge MIDI Si32-2	0107124
A	COAX® cartridge MIDI Si32-2, holding cap	0107126
D	COAX® cartridge MIDI Si32-2, extra non-return valve	0107709
B	COAX® cartridge MIDI Si32-2, holding cap, extra non-return valve	0107711

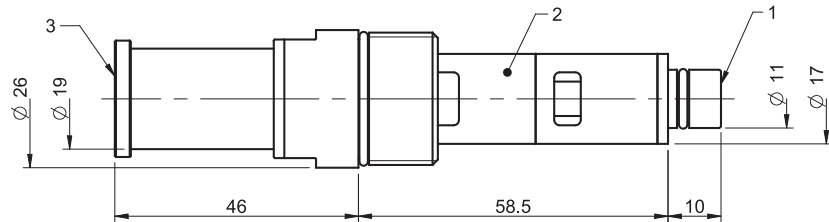
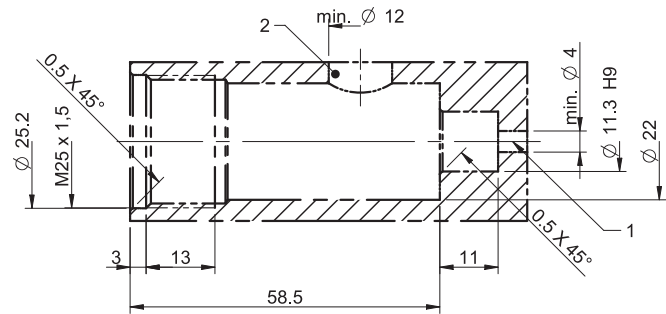
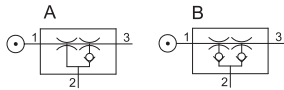
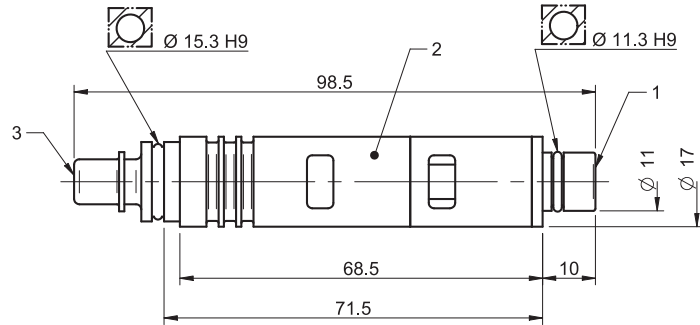
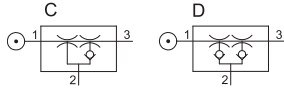

## Ordering information, accessories

Description	Art. No.
Silencer COAX® MIDI	0111976

## Si32-3



- ▶ Three-stage COAX® cartridge - MIDI - with extra high initial vacuum flow.
- ▶ Large vacuum flow in relation to energy consumption.
- ▶ Suitable for fast evacuation of large volumes when handling porous materials or if surface leakage is present.
- ▶ Efficient generator of blow-air.  
Recommended for low overpressures (0 - 0.05 MPa).

### Technical data

Description	Unit	Value
Feed pressure, max.	MPa	0.7
Temperature range	°C	-10-80
Weight	g	33-70
Material		Al, NBR, PA, SS

### Vacuum flow

Feed pressure MPa	Air consumption NI/s	Vacuum flow (NI/s) at different vacuum levels (-kPa)								Max vacuum -kPa
		0	10	20	30	40	50	60	70	
0.40	1.25	5.0	2.9	1.9	1.2	0.80	0.40	0.10	—	60
0.50	1.5	5.7	3.3	2.2	1.4	0.85	0.62	0.35	0.18	70
0.60	1.75	6.0	3.5	2.6	1.7	0.90	0.60	0.50	0.35	75

### Evacuation time

Feed pressure MPa	Air consumption NI/s	Evacuation time (s/l) to reach different vacuum levels (-kPa)								Max vacuum -kPa
		10	20	30	40	50	60	70		
0.40	1.25	0.030	0.070	0.14	0.24	0.42	1.0	—	60	
0.50	1.5	0.020	0.060	0.11	0.21	0.35	0.60	1.0	70	
0.60	1.75	0.020	0.050	0.10	0.18	0.33	0.53	0.80	75	

### Blow flow

Feed pressure MPa	Air consumption NI/s	Blow flow (NI/s) at different pressure levels (kPa)									Max pressure kPa
		0	10	20	30	40	50	60	70	80	
0.60	1.75	7.8	5.4	4.6	3.8	3.3	3.1	2.7	2.3	1.8	80

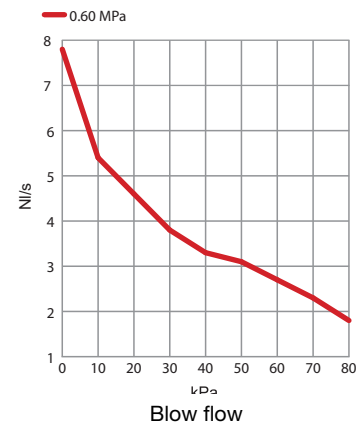
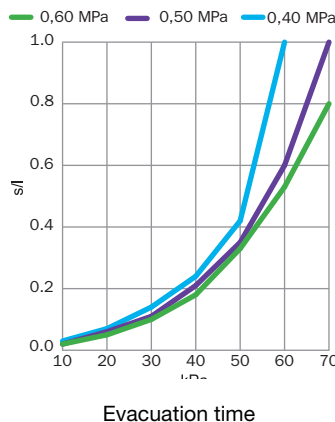
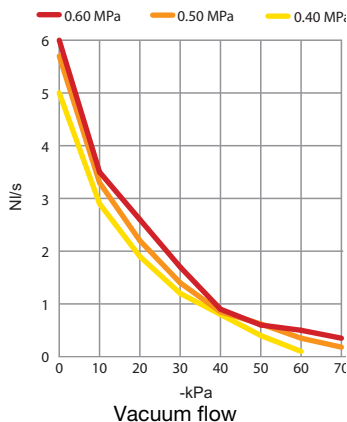

## Ordering information

	Description	Art. No.
C	COAX® cartridge MIDI Si32-3	0107053
A	COAX® cartridge MIDI Si32-3, holding cap	0107128
D	COAX® cartridge MIDI Si32-3, extra non-return valve	0107713
B	COAX® cartridge MIDI Si32-3, holding cap, extra non-return valve	0107715

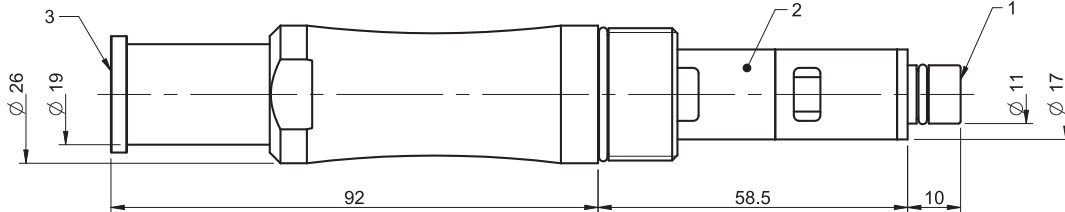
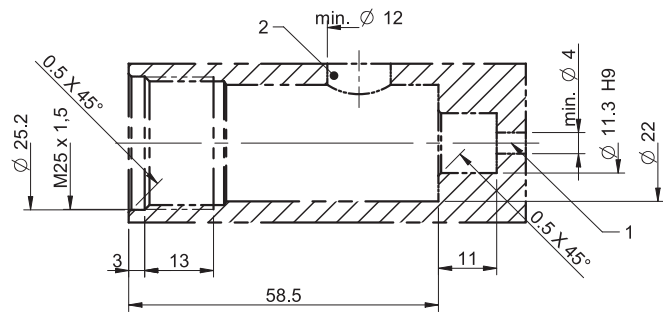
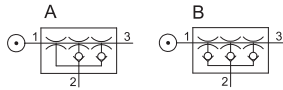
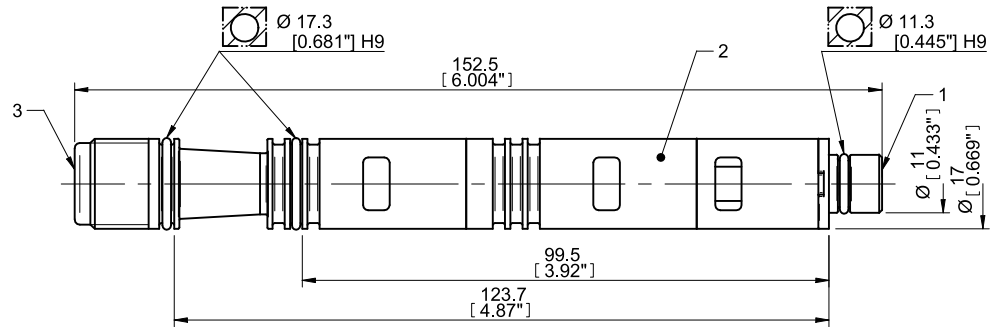
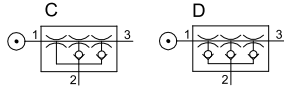

## Ordering information, accessories

Description	Art. No.
Silencer COAX® MIDI	0111976

## Xi40-2



- ▶ Two-stage COAX® cartridge – MIDI – with small mounting dimensions for limited spaces
- ▶ Deep end vacuum level, 95 -kPa
- ▶ High vacuum flow at deep vacuum levels, 75 to 95 -kPa
- ▶ Quick response time when deep vacuum is needed
- ▶ The all-round characteristics makes it suitable for several types of vacuum applications

### Technical data

Description	Unit	Value
Feed pressure, max.	MPa	0.7
Temperature range	°C	-10-80
Weight	g	18.5-54.7
Material		Al, NBR, PA, SS

### Vacuum flow

Feed pressure MPa	Air consumption NI/s	Vacuum flow (NI/s) at different vacuum levels (-kPa)											Max vacuum -kPa
		0	10	20	30	40	50	60	70	80	90		
0.45	1.83	2.8	2.3	1.6	1.0	0.73	0.58	0.43	0.32	0.18	0.03	95	
0.50	2.0	2.8	2.4	1.8	1.2	0.72	0.54	0.40	0.30	0.14	0.02	94	
0.60	2.33	2.7	2.4	2.0	1.5	0.90	0.52	0.40	0.31	0.16	0.03	94	

### Evacuation time

Feed pressure MPa	Air consumption NI/s	Evacuation time (s/l) to reach different vacuum levels (-kPa)										Max vacuum -kPa
		10	20	30	40	50	60	70	80	90		
0.45	1.83	0.04	0.09	0.17	0.28	0.44	0.63	0.90	1.3	2.3	95	
0.50	2.0	0.04	0.09	0.15	0.26	0.42	0.63	0.91	1.4	2.6	94	
0.60	2.33	0.04	0.08	0.14	0.23	0.37	0.58	0.87	1.3	2.3	94	

### Blow flow

Feed pressure MPa	Air consumption NI/s	Blow flow (NI/s) at different pressure levels (kPa)											Max pressure kPa
		0	10	20	30	40	50	60	70	80	90		
0.6	2.33	5.1	5.0	4.6	4.1	3.4	3.4	3.3	3.1	2.8	2.4	90	

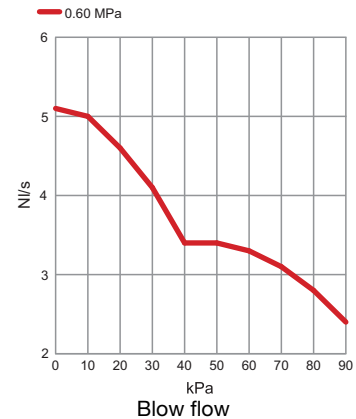
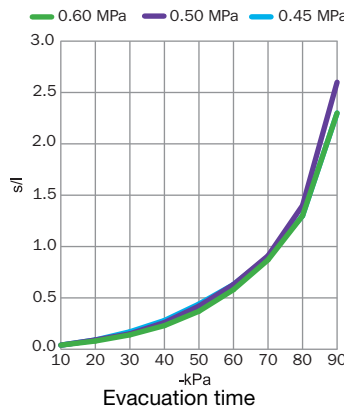
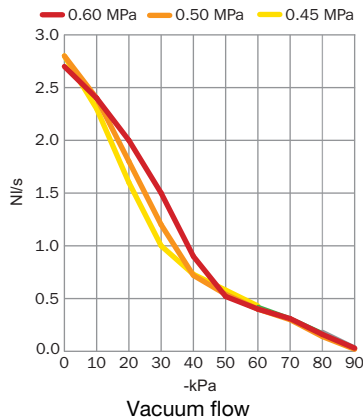



## Ordering information

	Description	Art. No.
C	COAX® cartridge MIDI Xi40-2	0118747
A	COAX® cartridge MIDI Xi40-2, holding cap	0118757
D	COAX® cartridge MIDI Xi40-2, extra non-return valve	0118748
B	COAX® cartridge MIDI Xi40-2, holding cap, extra non-return valve	0118758

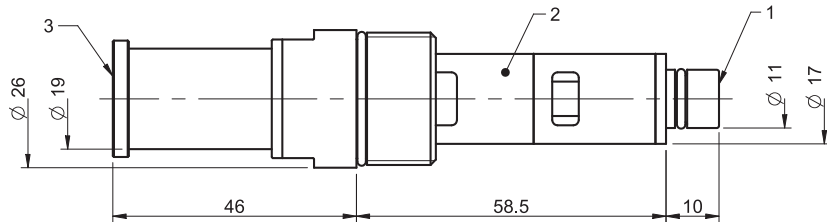
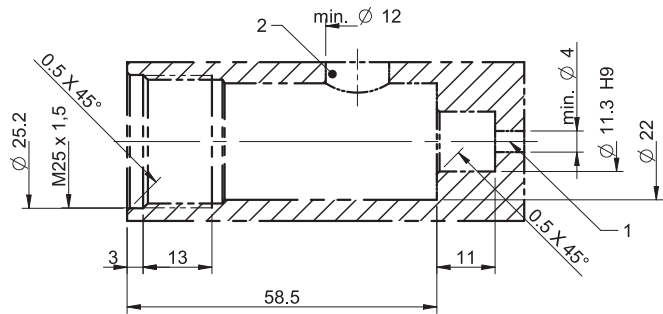
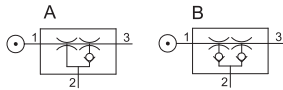
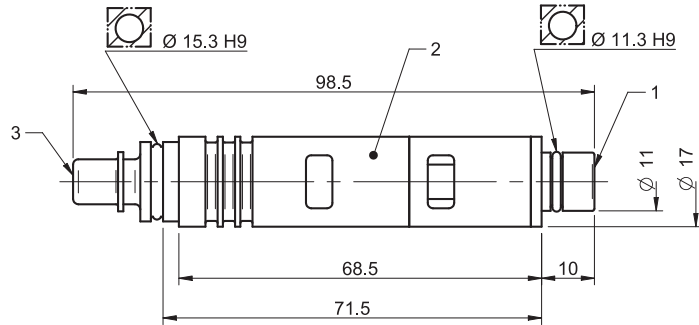
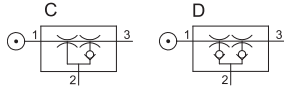

## Ordering information, accessories

Description	Art. No.
Silencer COAX® MIDI	0111976

## Xi40-3



- ▶ Three-stage COAX® cartridge – MIDI – with high initial vacuum flow
- ▶ Deep end vacuum level, 95 -kPa
- ▶ High vacuum flow at deep vacuum levels, 75 to 95 -kPa
- ▶ Quick response time when deep vacuum is needed
- ▶ The all-round characteristics makes it suitable for several types of vacuum applications

### Technical data

Description	Unit	Value
Feed pressure, max.	Mpa	0.7
Temperature range	°C	-10-80
Weight	g	28.7-63.2
Material		Al, NBR, PA, SS

### Vacuum flow

Feed pressure MPa	Air consumption NI/s	Vacuum flow (NI/s) at different vacuum levels (-kPa)											Max vacuum -kPa
		0	10	20	30	40	50	60	70	80	90		
0.45	1.83	5.9	3.0	2.0	1.3	0.73	0.58	0.43	0.32	0.18	0.03	95	
0.50	2.0	6.2	3.7	2.2	1.8	1.3	0.81	0.40	0.30	0.14	0.02	94	
0.60	2.33	5.9	3.2	2.2	1.6	0.90	0.52	0.40	0.31	0.16	0.03	94	

### Evacuation time

Feed pressure MPa	Air consumption NI/s	Evacuation time (s/l) to reach different vacuum levels (-kPa)										Max vacuum -kPa
		10	20	30	40	50	60	70	80	90		
0.45	1.83	0.022	0.062	0.12	0.22	0.37	0.57	0.84	1.2	2.2	95	
0.50	2.0	0.02	0.05	0.10	0.20	0.30	0.40	0.70	1.2	2.4	94	
0.60	2.33	0.02	0.054	0.10	0.17	0.26	0.43	0.71	1.2	2.4	94	

### Blow flow

Feed pressure MPa	Air consumption NI/s	Blow flow (NI/s) at different pressure levels (kPa)										Max pressure kPa
		0	10	20	30	40	50	60	70	80	90	
0.60	2.33	8.43	6.18	5.09	4.62	3.92	3.53	3.39	3.23	2.95	2.58	90

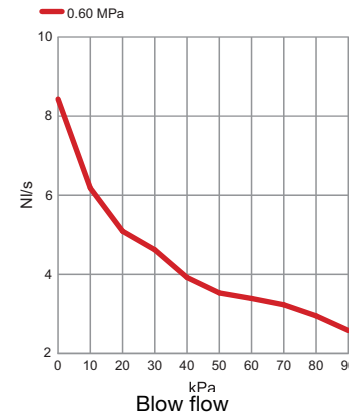
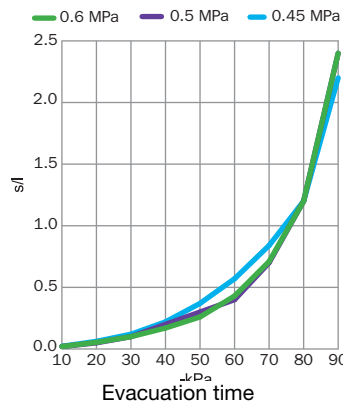
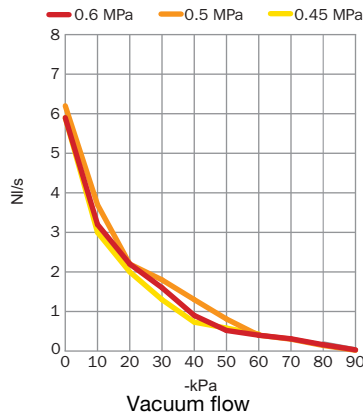

## Ordering information

	Description	Art. No.
C	COAX® cartridge MIDI Xi40-3	0118724
A	COAX® cartridge MIDI Xi40-3, holding cap	0118759
D	COAX® cartridge MIDI Xi40-3, extra non-return valve	0118725
B	COAX® cartridge MIDI Xi40-3, holding cap, extra non-return valve	0118760

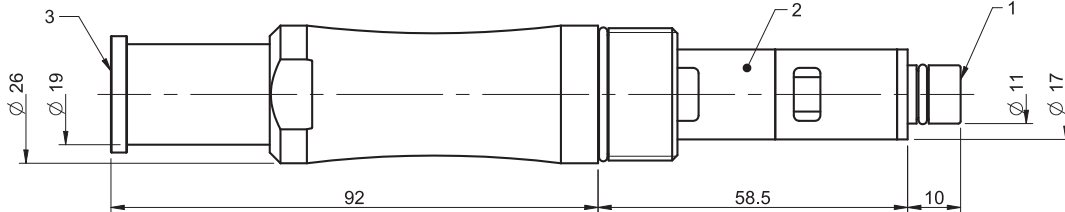
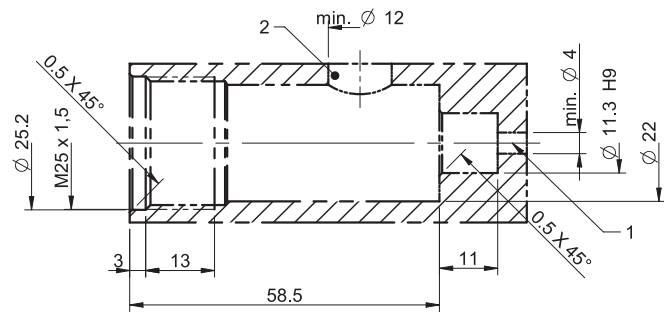
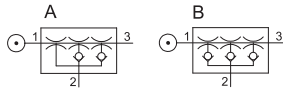
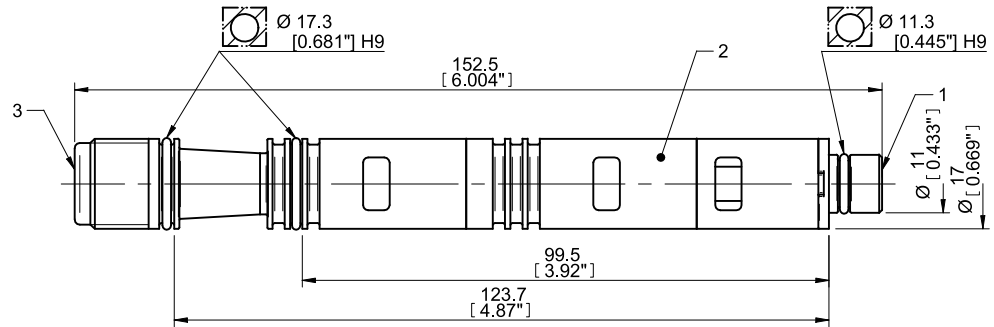
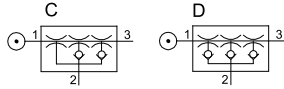

## Ordering information, accessories

Description	Art. No.
Silencer COAX® MIDI	0111976