

# Series CX multi-serial module

New 

Interface with: PROFIBUS, CANopen, DeviceNet, EtherNet/IP,  
PROFINET, EtherCAT  
Compatible with all Camozzi valve islands

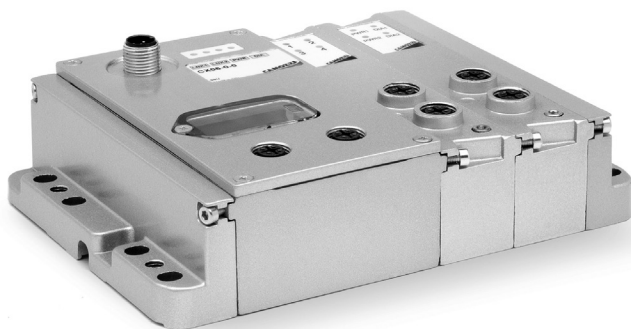

- » Maximum flexibility in use
- » Mounting in hard application conditions
- » Easily changeable
- » Analog I/O modules
- » Digital I/O modules
- » Multi-communication protocols

2

CONTROL

**The Series CX serial module, with IP65 protection class, interface with all major serial communication protocols as well as the new generation EtherCAT, EtherNet/IP and PROFINET protocols. The highly resistant aluminium structure makes it suitable for mountings even in hard application conditions.**

This serial module can be coupled with electric input and output modules and is able to handle up to a maximum of 1024 I/O. Its interface modules enable direct connection to Series F, HN and 3 valve islands. Through a subnet the connection system can be extended to remote valve islands.

Manuals, instruction sheets and configuration files are available on the site <http://catalogue.camozzi.com> or by means of the QR code indicated on the label of the product.

## GENERAL DATA

Number of digital outputs	1024
Number of digital inputs	1024
Maximum input absorption	1,5 A
Maximum output absorption	3 A
Logical supply voltage *	24 V DC +/-10%
Power supply voltage *	24 V DC +/-10%
Protection	overload and reverse polarity
Protection class	IP65
Conform with standards	EN-61326-1 EN-61010-1
Operating temperature	0-50°C
Material	Aluminium

\* the voltage range can change according to the range required by the external connected elements.

**CODING EXAMPLE**

<b>CX</b>	<b>05</b>	<b>-</b>	<b>2AC</b>	<b>-</b>	<b>QT2S</b>
-----------	-----------	----------	------------	----------	-------------

<b>CX</b>	SERIES
<b>05</b>	PROTOCOL: 01 = PROFIBUS 02 = DeviceNet 03 = CANopen 04 = EtherNet/IP 05 = EtherCAT 06 = PROFINET 99 = Expansion Module
<b>2AC</b>	INPUTS: 0 = no module nA = 8 digital inputs M8 nB = 4 digital inputs M8 nC = 2 IN 4-20 mA nD = 2 IN 0-10 V nE = 1 IN 4-20 mA + 1 IN 0-10 V
<b>QT2S</b>	OUTPUTS: 0 = no module nQ = 4 M12 duo digital outputs nR = 2 OUT 4-20 mA nT = 2 OUT 0-10 V nU = 1 OUT 4-20 mA + 1 OUT 0-10 V nV = 1 OUT 4-20 mA + 1 IN 0-10 V nZ = 1 OUT 4-20 mA + 1 IN 4-20 mA nK = 1 OUT 0-10 V + 1 IN 0-10 V nY = 1 OUT 0-10 V + 1 IN 4-20 mA nS = initial subnet module

**Fieldbus protocols - Technical data**

Protocol	Max nr of nodes defined by the protocol	Communication speed defined by the protocol	Max number of I/O	LED 1 Yellow-Green	LED 2 Yellow-Green	LED 3 Red-Green	LED 4 Red
<b>PROFIBUS</b>	32/127	9,6 kBit/s per 1000 m 12 Mbit/s per < 100 m	1024 Input 1024 Output	absent	Green RUN	Red DIA	Red BF
<b>CANopen</b>	127	125 kBit/s 500 m 1 Mbit/s per 4 m	1024 Input 1024 Output	absent	Green IO	Red DIA	Red BF
<b>DeviceNet</b>	64	125 kBit/s 500 m 500 kbit/s per 100 m	1024 Input 1024 Output	absent	Green RUN	Red NS	Red MF
<b>PROFINET</b>	unlimited	100 Mbit/s per 100 m	1024 Input 1024 Output	Yellow LNK1	Yellow LNK2	Green PWR	Red DIA
<b>EtherNet/IP</b>	unlimited	100 Mbit/s per 100 m	1024 Input 1024 Output	Yellow LNK1	Yellow LNK2	Green PWR	Red DIA
<b>EtherCAT</b>	unlimited	100 Mbit/s per 100 m	1024 Input 1024 Output	Yellow LNK1	Yellow LNK2	Green PWR	Red DIA

### CPU Module - pin configuration

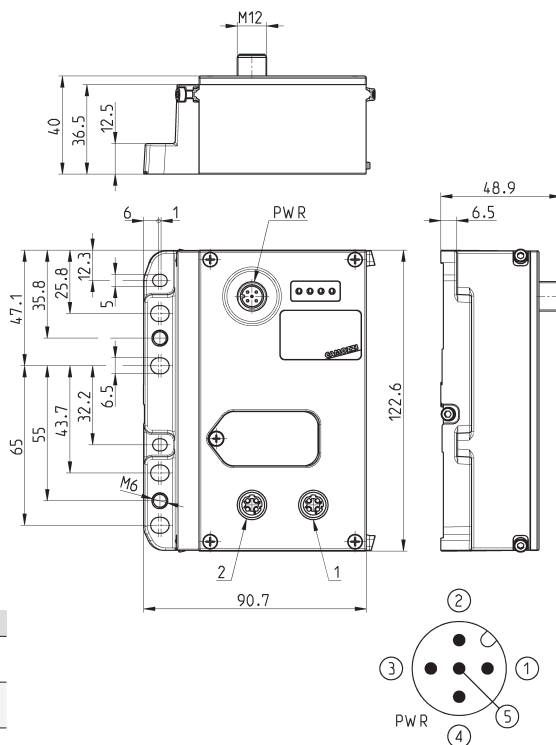

Mod.	Coding reference	Fieldbus Protocol	2	1	Bus-IN connector	Bus-OUT connector
CX01-0-0	01	PROFIBUS	Bus-IN	Bus-OUT	M12 B 5 pin male	M12 B 5 pin female
CX02-0-0	02	DeviceNet	Bus-IN	Bus-OUT	M12 A 5 pin male	M12 A 5 pin female
CX03-0-0	03	CANopen	Bus-IN	Bus-OUT	M12 A 5 pin male	M12 A 5 pin female
CX04-0-0	04	EtherNet/IP	Bus-OUT	Bus-IN	M12 D 5 pin female	M12 D 5 pin female
CX05-0-0	05	EtherCAT	Bus-OUT	Bus-IN	M12 D 5 pin female	M12 D 5 pin female
CX06-0-0	06	PROFINET	Bus-OUT	Bus-IN	M12 D 5 pin female	M12 D 5 pin female

### Expansion Module - pin configuration



Note: to connect the Expansion with the subnet, we recommend the use of cables Mod. CS-SB04HB... or CS-SC04HB...

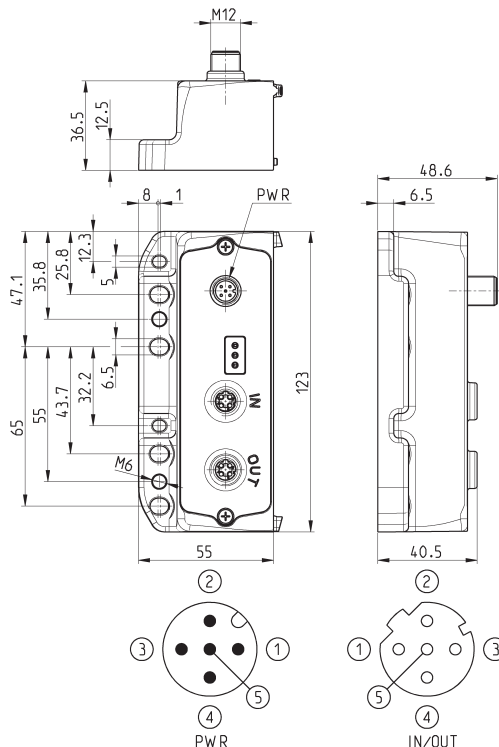

Mod.	Coding reference	Fieldbus Protocol	Bus-IN and Bus-OUT connector
CX99-0-0	99	Subnet expansion	M12 D 5 pin female

### CPU Module - Characteristics

It is a slave node of the main PROFIBUS, CANopen, DeviceNet, EtherNet/IP, EtherCAT, PROFINET network and the Master module of the subnet. All modules provided can be connected only on the right side of the CPU module, like the digital/analog inputs/outputs, direct interface modules for the valve islands (Series F, HN and 3) and the initial module of the subnet.

It has its own M12 A 4 pin male connection to supply the modules connected, distinguishing both logic supply and power supply.

Two M12 connections for Bus-IN and Bus-OUT of the main network, which M12 connection will take over the relative specifications according to the chosen protocol.

The addressing is performed by means of the Rotary Switch for the protocols with this feature, while for Ethernet protocols addressing is performed by means of the protocol itself. Leds indicate the working state. A maximum number of 1024 inputs and 1024 outputs can be managed.

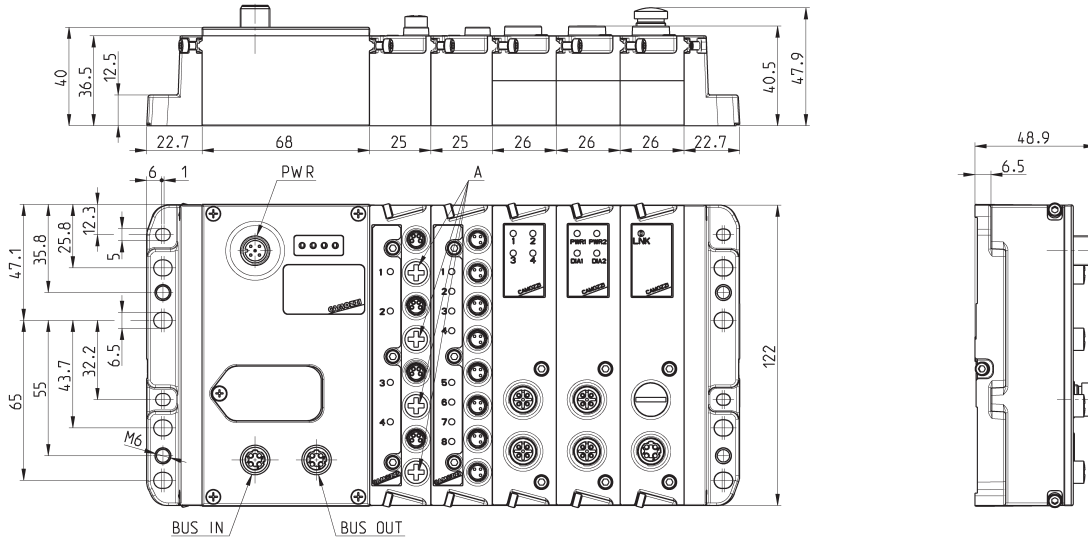

### Expansion Module - Characteristics

At its right side, different modules can be connected like the digital/analog inputs/outputs, the direct interface modules for the valve islands (Series F, HN and 3) and the initial module of the subnet to re-amplify it or to create new branches. It has its own M12 A 4 pin male connection to supply the devices connected, distinguishing both logic supply and power supply. It has two M12 D 5 pin female connections for Bus-IN and Bus-OUT connection of the subnet. Leds indicate the working state.

The valve island equipped with Expansion Module can be used only in presence of a subnet.

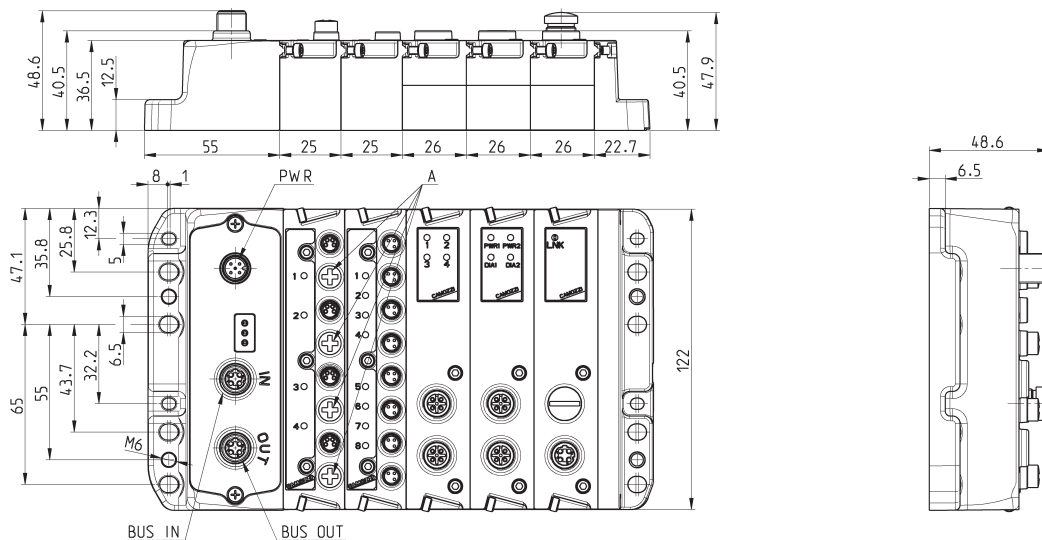

### Initial subnet module Mod. ME3-0000-SL

This module can be connected only in presence of a CPU or Expansion module and can be mixed with other either digital or analog Input and Output devices.

Every subnet can have an extension of maximum 100 metres, with a maximum of 8 interruptions. Up to maximum 5 initial modules can be connected, one aside another or along the subnet in order to create a tree structure, in series or both, in order to optimize the length of the cables and the topology of the subnet in different applications. The module is equipped with the Bus-OUT connection only of subnet type M12 D 5 pin female.

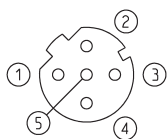

Mod.	Coding reference	Bus-OUT connection	Max number of modules for subnet	Max extension of subnet per module
<b>ME3-0000-SL</b>	S	M12D 5 pin female	5	100 m

### Sub-D adaptor module 25 and 37 pin Mod. CXA-25P and CXA-37P



Led 1 = Yellow LNK1  
 Led 2 = Yellow LNK2  
 Led 3 = Green PWR, supply present and OK

It is an Expansion module of the subnet and can be connected to all valve islands with Sub-D 25 pin connection (Series F, HN and 3) or 37 pin connection (Series HN). It has its own M12A 4 pin male connection for the supply of the valves connected, distinguishing both logic supply and power supply and two M12 D 5 pin female connections for the Bus-IN and Bus-OUT of the subnet. The subnet can have a length of maximum 100 metres. The 25 pin adaptor module manages a fixed number of 24 digital outputs, while the 37 pin adaptor module manages a fixed number of 32 digital outputs. In both cases, every output can provide a maximum of 3 W to 24 V DC, with PWM outputs for which it is possible to set the working frequency value.

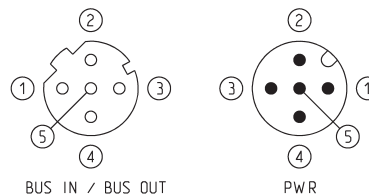
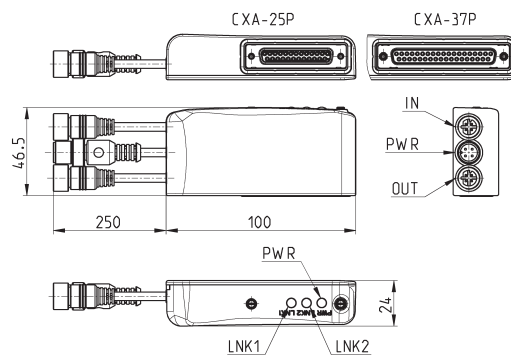

Mod.	Interface	Digital Outs	Bus-IN connection	Bus-OUT connection	PWR connection	Supply	Power for every Output
<b>CXA-25P</b>	Sub-D 25 pin	24	M12D 5 pin female	M12D 5 pin female	M12A 4 pin male	24 V DC	3 W
<b>CXA-37P</b>	Sub-D 37 pin	32	M12D 5 pin female	M12D 5 pin female	M12A 4 pin male	24 V DC	3 W

## Digital input Module Mod. ME3-0800-DC and ME3-0400-DC

The Digital input module can be connected only in presence of a CPU or Expansion module and can be mixed with other either digital or analog Input and Output devices and with the initial module of the subnet.

It has 8 or 4 M8 3 pin connections.

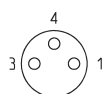

Mod.	Coding reference	Number of digital inputs	Connection	Number of connectors	Dimensions	Signalling	Sensor supply	Overvoltage protection	Absorption	Type of signal	Protection class	Operating temperature	Weight
<b>ME3-0800-DC</b>	A	8	M8 3 pin female	8	122 x 25 mm	1 yellow led for each input	24 V DC	400 mA for 4 sensors	10 mA	PNP	IP65	0 + 50°C	110 g
<b>ME3-0400-DC</b>	B	4	M8 3 pin female	4	122 x 25 mm	1 yellow led for each input	24 V DC	400 mA for 4 sensors	10 mA	PNP	IP65	0 + 50°C	110 g

## Analog input/output module Mod. ME3-\*\*\*\*-AL

The analog input/output module can be connected only in presence of a CPU or Expansion module and can be mixed with other either digital or analog Input and Output devices and with the initial module of the subnet. It has two M12 A 5 female pin connections and it can be configured as 2 analog Outputs or 2 Inputs or 1 Input + 1 Output. Every output or input occupies 12 digital I/O, in order to create a 12 bit digital/analogic conversion, for both inputs and outputs available in the versions from 0-10 V DC and from 4-20mA.

The refreshment time of the analog devices is submitted to the delay of the subnet and therefore to its topology. An average delay is less than 6 ms, to which the delay of the main network managed by the PLC has to be added.

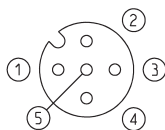

Mod.	Coding reference	Number of analog inputs	Number of analog outputs	Connection
<b>ME3-C000-AL</b>	C	2 inputs 4-20 mA	-	2x M12 A 5 pin female
<b>ME3-D000-AL</b>	D	2 inputs 0-10 V	-	2x M12 A 5 pin female
<b>ME3-E000-AL</b>	E	1 input 4-20 mA + 1 input 0-10 V	-	2x M12 A 5 pin female
<b>ME3-00U0-AL</b>	U	-	1 output 4-20 mA + 1 output 0-10 V	2x M12 A 5 pin female
<b>ME3-00R0-AL</b>	R	-	2 outputs 4-20 mA	2x M12 A 5 pin female
<b>ME3-00T0-AL</b>	T	-	2 outputs 0-10 V	2x M12 A 5 pin female
<b>ME3-00Z0-AL</b>	Z	1 input 4-20 mA	1 output 4-20 mA	2x M12 A 5 pin female
<b>ME3-00K0-AL</b>	K	1 input 0-10 V	1 output 0-10 V	2x M12 A 5 pin female
<b>ME3-00V0-AL</b>	V	1 input 0-10 V	1 output 4-20 mA	2x M12 A 5 pin female
<b>ME3-00Y0-AL</b>	Y	1 input 4-20 mA	1 output 0-10 V	2x M12 A 5 pin female

### Digital power output module Mod. ME3-0004-DL

The digital output module can be connected only in presence of a CPU or Expansion module and can be mixed with other either digital or analog Input and Output devices and with the initial module of the subnet. It has two M12 A 5 pin female connections, each connection can manage 2 digital outputs and can provide a maximum of 10 W to 24 V DC. The device is useful to pilot a bistable valve or two monostable valves for each connector, or to activate the electric coils or other electric devices with maximum absorption of 10 W to 24 V DC. Connecting two outputs to one electric device only and activating them simultaneously, it is possible to provide maximum 20 W to 24 V DC.

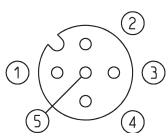

2

CONTROL

Mod.	Coding reference	Number of digital outputs	Connection	Number of connectors	Dimensions	Signalling	Sensor supply	Max power for M12 connector	Max power for digital output	Type of signal	Protection class	Operating temperature	Weight
ME3-0004-DL	Q	4	M12 A 5 pin female	2	122 x 25 mm	1 yellow led for each output	24 V DC	20 W	10 W	PNP	IP65	0 ÷ 50°C	100 g

### Direct interface with Series F, Series HN and Series 3 valve islands

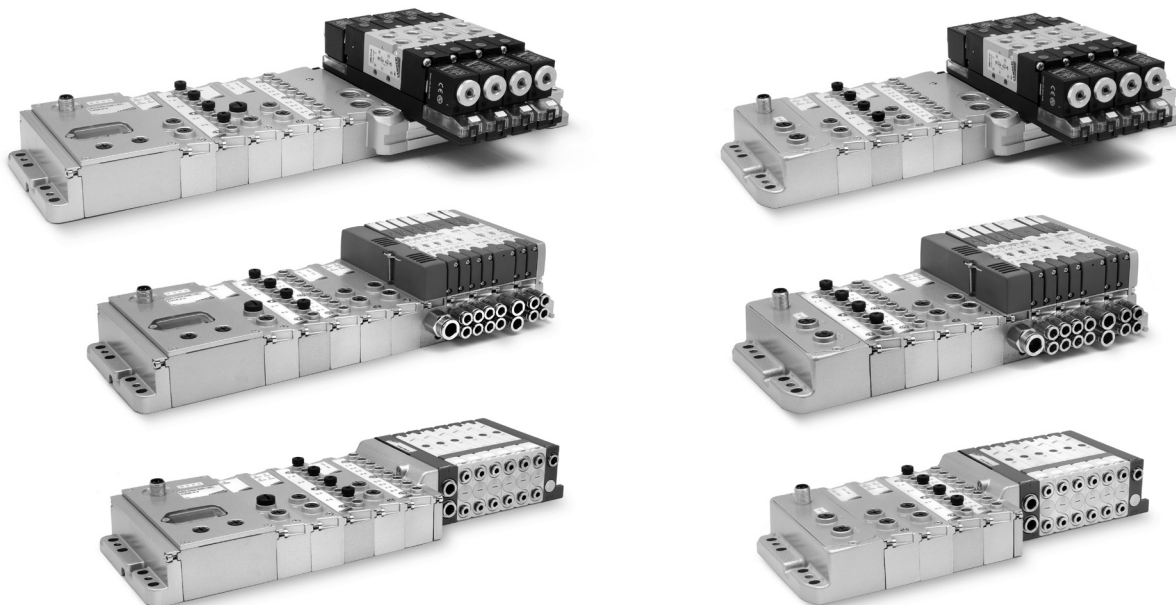

These direct interface modules allow to connect a CPU, CX or an expansion module directly to a valve island of the Series F, HN or 3. Before these interface modules you can only connect different digital or analog electric modules or the initial module of the subnet.

Downstream the interface modules, only the provided valve islands can be connected. The valve islands that can be connected to the interface modules have the same rules as the multipole version of the same Series.

## Network topology configuration with the CX solution - Example 1

Multi-serial solution composed of:

- a CX module with initial subnet module
- a Series 3 Multipole valve island with CXA-25P adaptor
- a Series HN Multipole valve island with CXA-25P adaptor
- a Series F Multipole valve island with CXA-25P adaptor

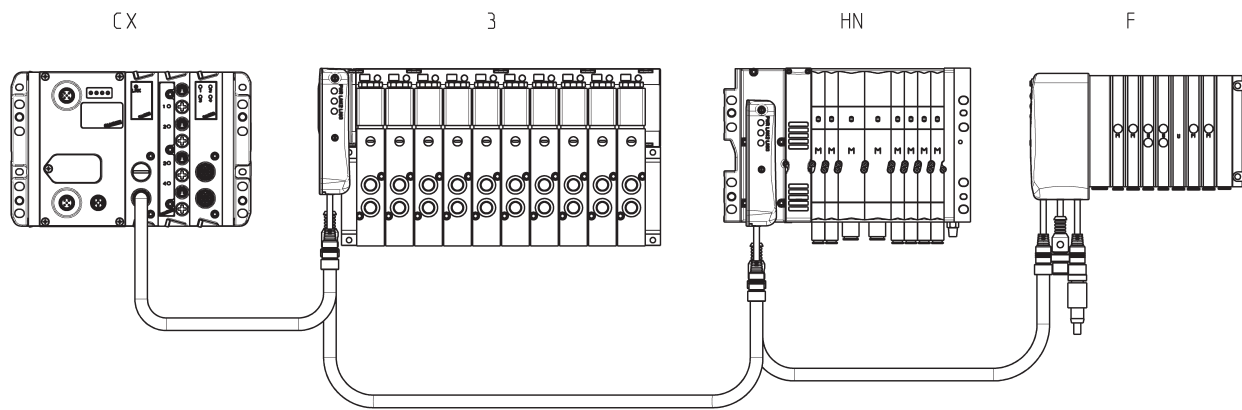

## Network topology configuration with the CX solution - Example 2

Multi-serial solution composed of:

- a Series F Fieldbus valve island
- a Series HN Fieldbus expansion
- a Series 3 Fieldbus Expansion
- a Series F Multipole valve island with CXA-25P adaptor

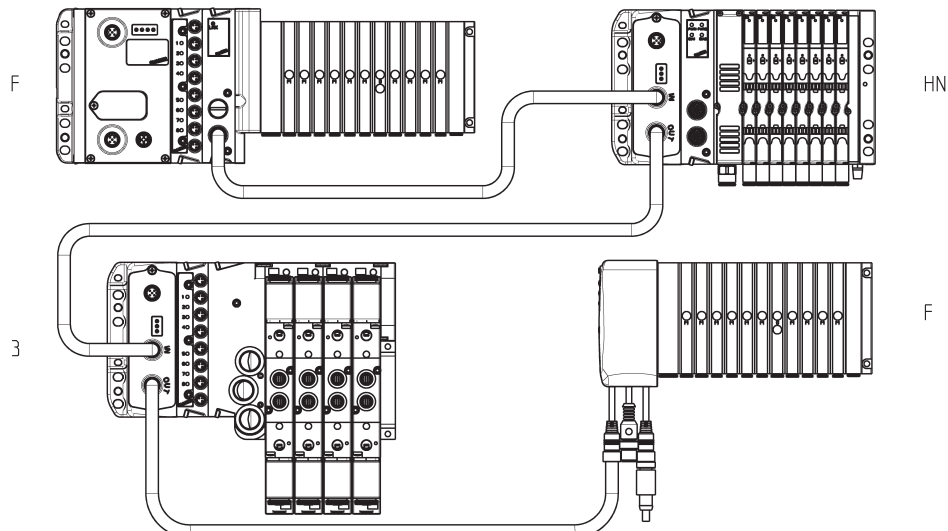



Network topology configuration with the CX solution - Example 3

Multi-serial solution with star connection composed of:

- a Series HN Fieldbus valve island with initial subnet modules
- on the first branch a Series F Multipole valve island with CXA-25P adaptor
- on the second branch a Series 3 Multipole valve island with CXA-25P adaptor
- on the third branch a Series F Multipole valve island with CXA-25P adaptor
- on the fourth branch a Series HN Multipole valve island with CXA-37P adaptor

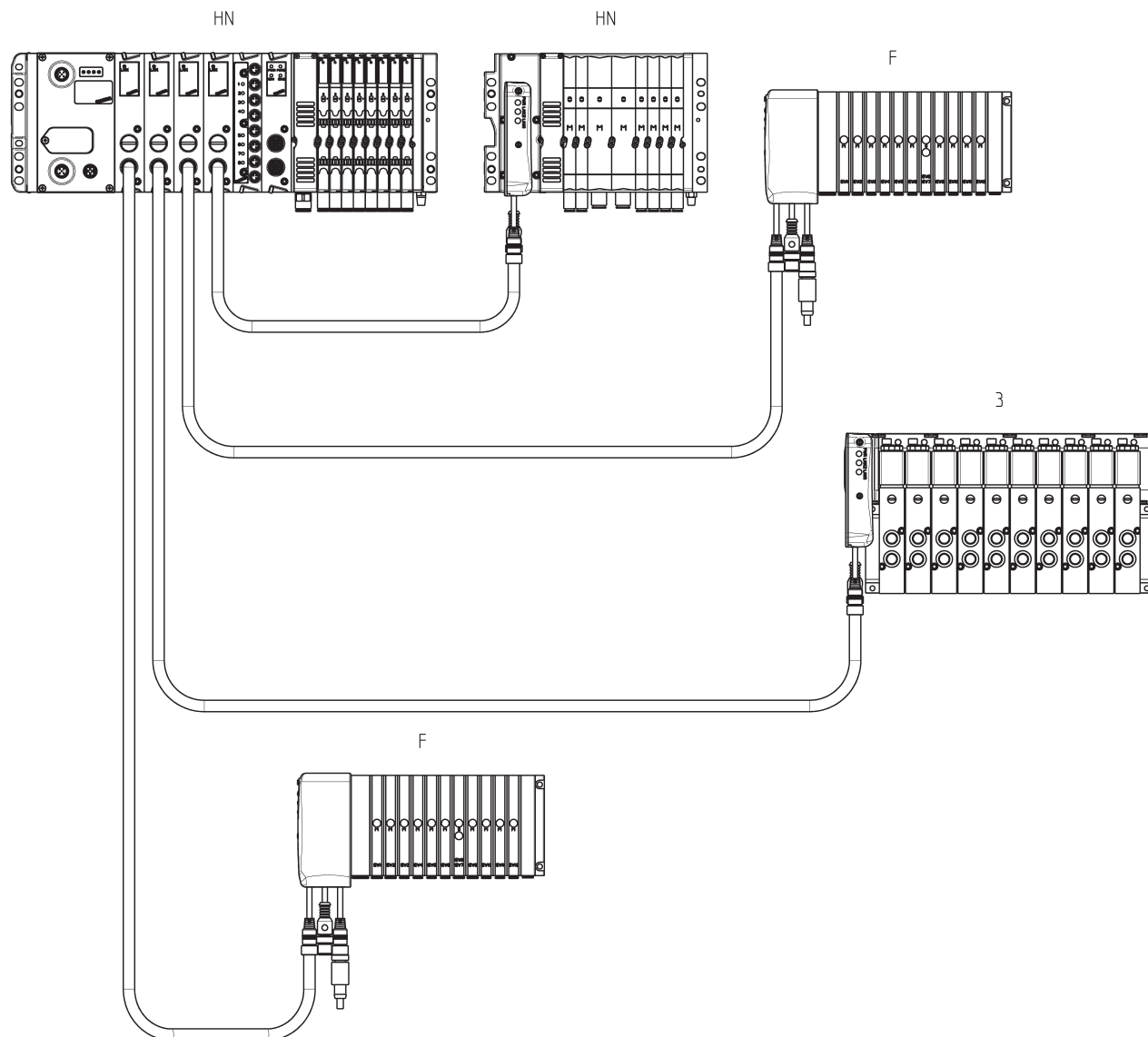

## Network topology configuration with the CX solution - Example 4

Multi-serial solution with tree connection composed of an initial module, two branches and a further branch.

Initial module:

- Series 3 Fieldbus valve island with 2 initial subnet modules

First branch of the initial module:

- 5 Series F valve islands of which 3 Fieldbus and 2 Multipole with CXA-25P adaptor

Further branch:

- 2 Series HN Multipole valve islands with CXA-25P and CXA-37P adaptor

Second branch of the initial module:

- a Series F Fieldbus Expansion

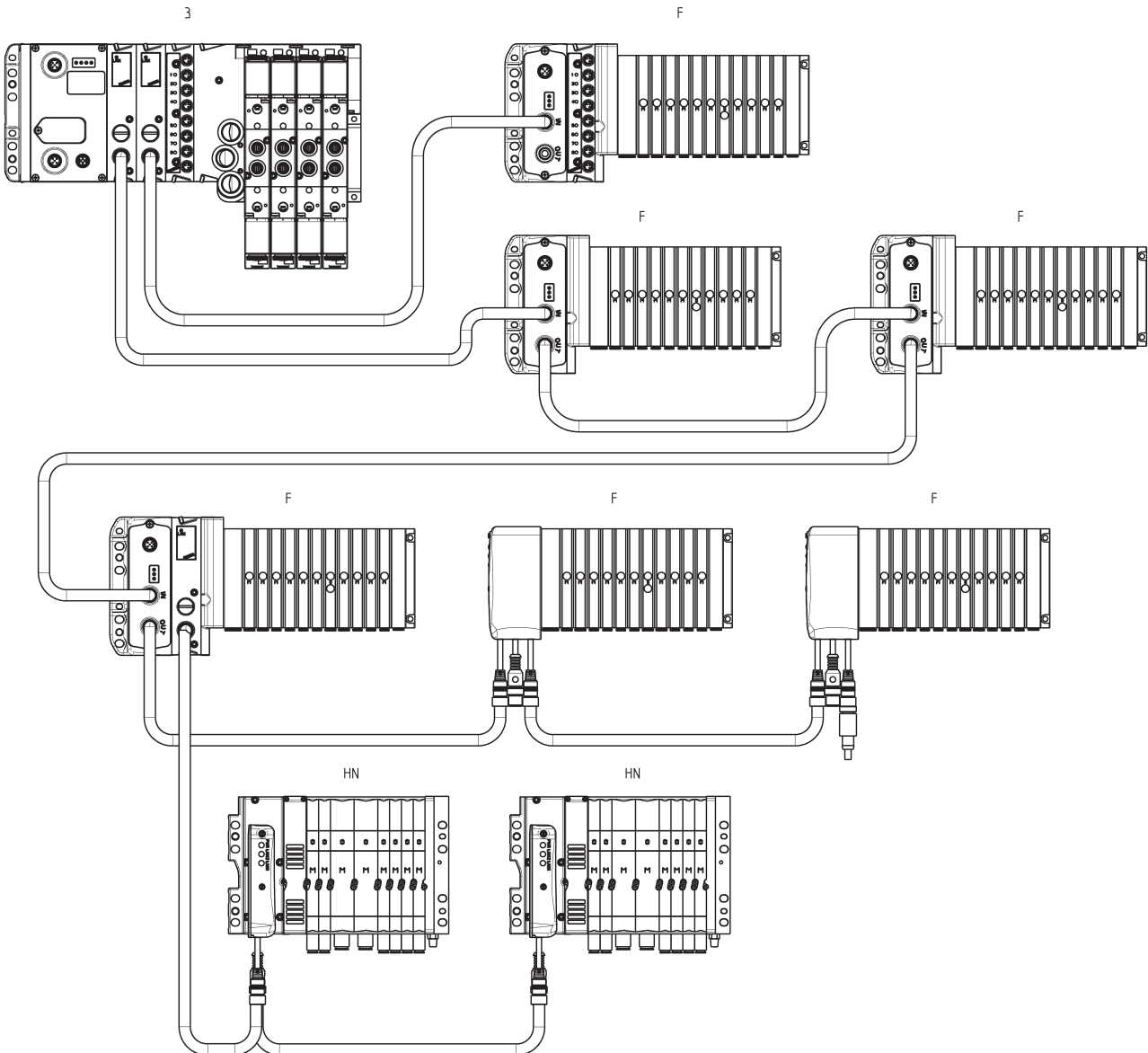

### Adaptor and panel mount for Ethernet RJ45 to M12 D networks

For PROFINET, EtherCAT, EtherNet/IP

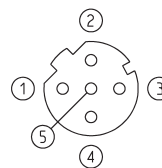
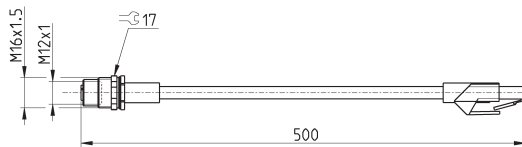

Mod.	description	type of connector	connection	cable length (m)
CS-SE04HB-F050	moulded cable	straight	RJ45 male, M12 D 4 pin female	0.5

### 25M-25F Sub-D adaptor

For Series Y valve islands with CXA-25P

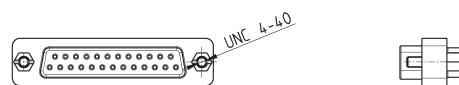
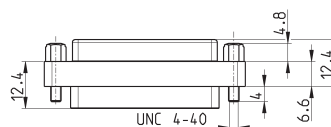

Mod.	description	type of connector	connection	cable length (m)
G2X-G2W	moulded adaptor	in line	Sub-D 25 pin female - male	-

### Profibus-DP data line tee

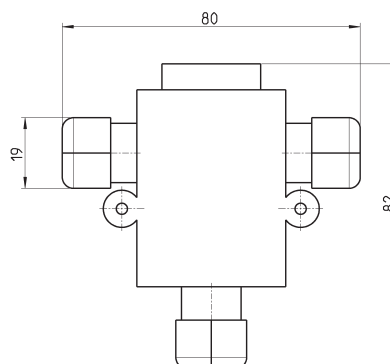

Mod.	CS-AA03EC
------	-----------

### CANopen / DeviceNet data line tee

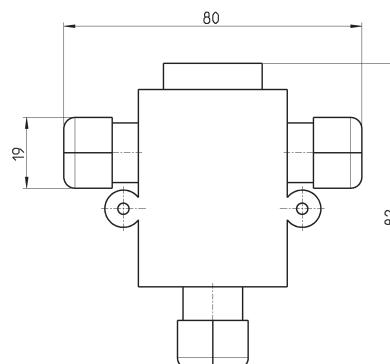

Mod.	CS-AA05EC
------	-----------

### M12 male terminating resistor

For PROFIBUS, CANopen, DeviceNet

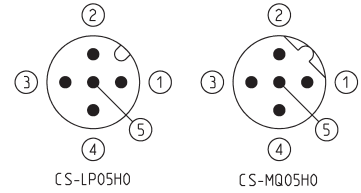
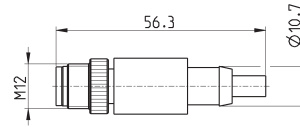

Mod.	description	type of connector	connection	Protocol
<b>CS-MQ05H0</b>	moulded terminating resistor	straight	M12 B 4 pin male	PROFIBUS
<b>CS-LP05H0</b>	moulded terminating resistor	straight	M12 A 5 pin male	CANOpen / DeviceNet

### Subnet terminating resistor

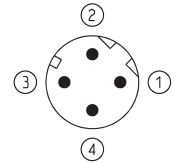
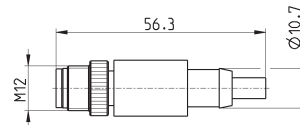

Mod.	description	type of connector	connection	Protocol
<b>CS-SU04H0</b>	moulded terminating resistor	straight	M12 D 4 pin	subnet

### Straight connector for power supply

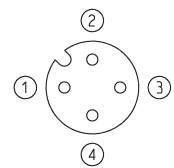
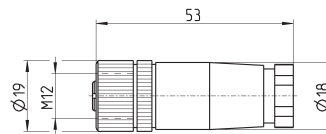

Mod.	description	type of connector	connection	cable length (m)
<b>CS-LF04HB</b>	for wiring	straight	M12 A 4 pin female	-

### Angular connector for power supply

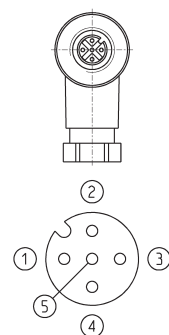
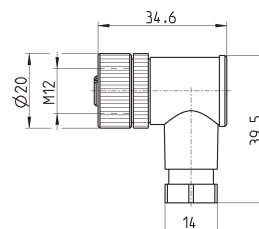

Mod.	description	type of connector	connection	cable length (m)
<b>CS-LR04HB</b>	for wiring	90°	M12 A 4 pin female	-

### Straight female M12 connectors for Bus-IN

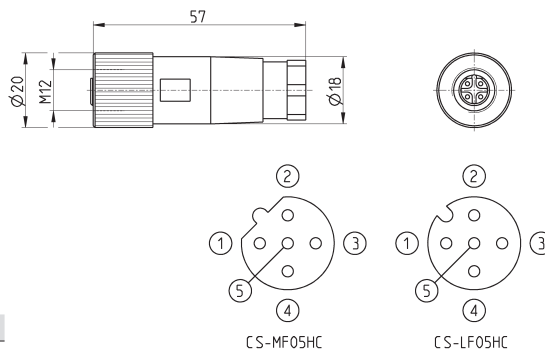

Mod.	description	type of connector	connection	Protocol
<b>CS-LF05HC</b>	for wiring	straight	M12 A 5 pin female	CANopen / DeviceNet
<b>CS-MF05HC</b>	for wiring	straight	M12 B 5 pin female	PROFIBUS

### Angular 90° female M12 connectors for Bus-IN

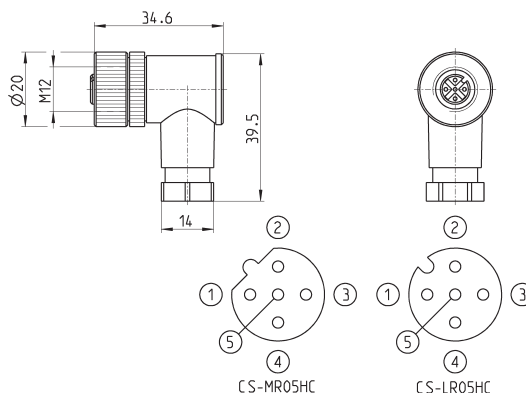

Mod.	description	type of connector	connection	Protocol
<b>CS-LR05HC</b>	for wiring	90°	M12 A 5 pin female	CANopen / DeviceNet
<b>CS-MR05HC</b>	for wiring	90°	M12 B 5 pin female	PROFIBUS

### Straight male M12 connectors for Bus-OUT

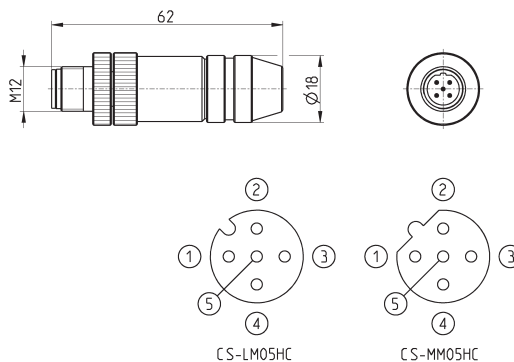

Mod.	description	type of connector	connection	Protocol
<b>CS-LM05HC</b>	for metal wiring	straight	M12 A 5 pin male	CANopen / DeviceNet
<b>CS-MM05HC</b>	for metal wiring	straight	M12 B 5 pin male	PROFIBUS

### Angular 90° male M12 connectors for Bus-OUT



The Mod. CS-LS05HC can also be used for the connection of the digital output modules and of the analog input and output modules.

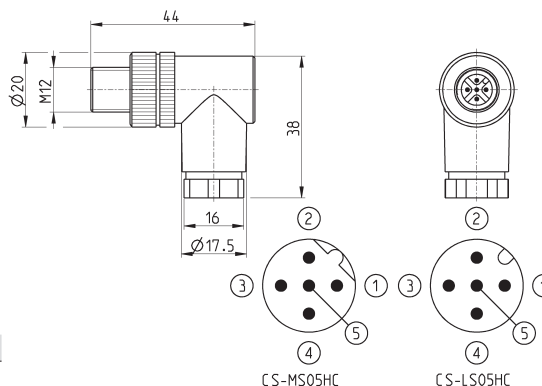

Mod.	description	type of connector	connection	Protocol
<b>CS-LS05HC</b>	for wiring	90°	M12 A 5 pin male	CANopen / DeviceNet
<b>CS-MS05HC</b>	for wiring	90°	M12 B 5 pin male	PROFIBUS

### 5 pin male straight M12 DUO connector



For the connection of the digital output modules and analog input/output modules.

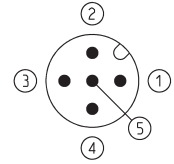
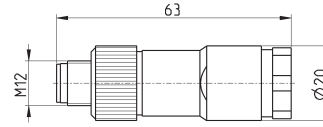

Mod.	description	type of connector	connection	cable length (m)
CS-LD05HF	for wiring	straight	M12 A 5 pin male	-

### 5 pin male angular M12 DUO connector



For the connection of the digital output modules ME3-0004-DL

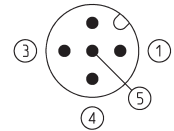
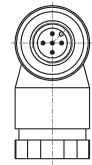
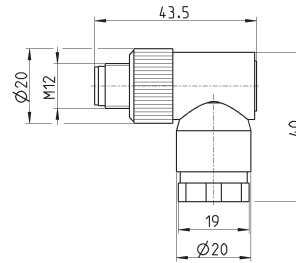

Mod.	description	type of connector	connection	cable length (m)
CS-LH05HF	for wiring	90°	M12 A 5 pin male	-

### 3 pin male M8 wiring connector for digital input modules

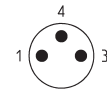
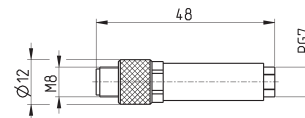

Mod.	description	type of connector	connection	cable length (m)
CS-DM03HB	for wiring	straight	M8 3 pin male	-

### Male wiring connector for Bus-IN and Bus-OUT



For PROFINET, EtherCAT, EtherNet/IP and subnet

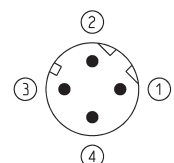
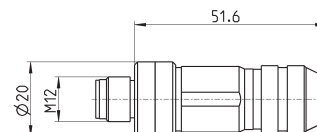

Mod.	description	type of connector	connection	cable length (m)
CS-SM04H0	for metal wiring	straight	M12 D 4 pin	-

Extension with M8 connector, 3 pin male / female

Non shielded

For the connection of the digital input modules ME3-0008 and ME3-0004

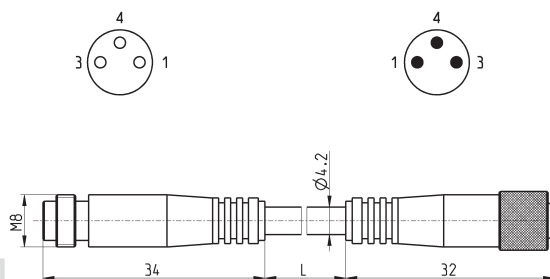

Mod.	description	type of connector	connection	L [ cable length ] (m)
CS-DW03HB-C250	moulded cable	straight	M8 3 pin male / female	2.5
CS-DW03HB-C500	moulded cable	straight	M8 3 pin male / female	5

Cable with straight connectors

For PROFINET, EtherCAT, EtherNet/IP and subnet

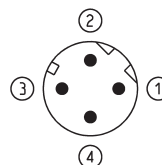

Mod.	description	type of connector	connection	L [ cable length ] (m)
CS-SB04HB-D100	moulded cable	straight	2x M12 D 4 pin male	1
CS-SB04HB-D500	moulded cable	straight	2x M12 D 4 pin male	5
CS-SB04HB-DA00	moulded cable	straight	2x M12 D 4 pin male	10

Cable with 90° angular connectors

For PROFINET, EtherCAT, EtherNet/IP and subnet

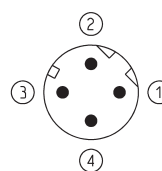
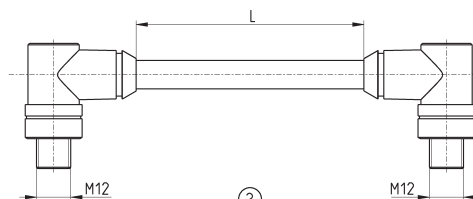

Mod.	description	type of connector	connection	L [ cable length ] (m)
CS-SC04HB-D100	moulded cable	90°	2x M12 D 4 pin male	1
CS-SC04HB-D500	moulded cable	90°	2x M12 D 4 pin male	5
CS-SC04HB-DA00	moulded cable	90°	2x M12 D 4 pin male	10

M8 and M12 connector cover caps

For digital and analog input/output modules and subnet



Mod.	A	B	C [ Connection ]
CS-DFTP	10	11	M8
CS-LFTP	13.5	13	M12

## Mounting brackets for DIN rail

DIN EN 50022 (mm 7,5 x 35 - width 1)

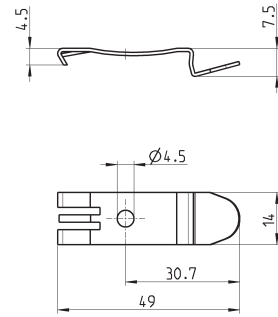
Supplied with:  
2x plates  
2x screws M4x6 UNI 5931

2

Mod.  
PCF-E520

CONTROL