

# Series ER100 digital electro-pneumatic regulators

Port G1/4



- » Compact design
- » Digital display
- » Analog and digital input
- » Programmable
- » Zero/span adjustment function
- » Error display function, pressure display
- » Preset memory function 8-set points (3 bits).

2

CONTROL

## GENERAL DATA ER104-5xxx

Model	ER104-5 0/1/2 X Analog type	ER104-5 P X Parallel type
Fluid	filtered compressed air, unlubricated, according to ISO 8573-1 class 3.4.3, inert gas	filtered compressed air, unlubricated, according to ISO 8573-1 class 3.4.3, inert gas
Max. working pressure	7 bar	7 bar
Min. working pressure	Control pressure + max. control pressure x 0,2	Control pressure + max. control pressure x 0,2
Pressure control range	0,3 ÷ 5 bar	0,3 ÷ 5 bar
Class protection	IP40	IP40
Power supply voltage	24 V DC +/- 10% (stabilized power supply with a ripple rate of 1% or less)	24 V DC +/- 10% (stabilized power supply with a ripple rate of 1% or less)
Consumption current	0.15 A (or less rush current 0.6 A or less when power is turned on)	0.15 A (or less rush current 0.6 A or less when power is turned on)
Input signal (Input impedance)	0 ÷ 10 V DC (6,7 kΩ) 0 ÷ 5 V DC (10 kΩ) 4 ÷ 20 mA DC ( 250 Ω)	10 bit
Preset input	8 points	N/A
Output signal Note 1	Analog output 1-5 VDC (load to be connected impedance 500 kW or more) Switch output NPN or PNP, open collector output, 30 V or less, 50 mA or less, voltage drop 2.4 or less, compatible for use with PLC or Relay	Analog output 1-5 VDC (load to be connected impedance 500 kW or more) Switch output NPN or PNP, open collector output, 30 V or less, 50 mA or less, voltage drop 2.4 or less, compatible for use with PLC or Relay
Error Output signal	NPN or PNP open collector output, 30 V or less, 50 mA or less, voltage drop 2,4 V or less, compatible for use with PLC or Relay	NPN or PNP open collector output, 30 V or less, 50 mA or less, voltage drop 2,4 V or less, compatible for use with PLC or Relay
Direct memory setting	0,05 ÷ 5 bar minimum input width 0,01 bar	0,05 ÷ 5 bar minimum input width 0,01 bar
Hysteresis Note 2	0.5% F.S. or less	0.5% F.S. or less
Linearity Note 2	±0.3% F.S. or less	±0.3% F.S. or less
Resolution Note 2	0.2% F.S. or less	0.2% F.S. or less
Repeatability Note 2	0.3% F.S. or less	0.3% F.S. or less
Temperature characteristics: Zero point fluctation	0.15% F.S./°C or less	0.15% F.S./°C or less
Temperature characteristics: Span point fluctation	0.07% F.S./°C or less	0.07% F.S./°C or less
Max. flow rate (ANR ) Note 3	400 l/min (see diagram)	400 l/min (see diagram)
Step response time No load Note 4	0.2 sec. or less	0.2 sec. or less
Step response time 1000 cm <sup>3</sup> load Note 4	0.8 sec. or less	0.8 sec. or less
Mechanical vibration proof	98 m/s <sup>2</sup> or less	98 m/s <sup>2</sup> or less
Ambient temperature	5°C ÷ 50 °C	5°C ÷ 50 °C
Fluid temperature	5°C ÷ 50 °C	5°C ÷ 50 °C
Connection port size	G1/4	G1/4
Mounting direction	Free	Free
Weight	250g	250g
Note 1:	Select either analog or switch output.	
Note 2:	This characteristic is guaranteed within a regulation range between 10 and 90% of the full scale, with a power voltage of 24V±10%, a supply pressure of 1 bar higher compared with the set pressure (ex. regulation of 3 bar, supply pressure of 3+1 = 4 bar) and a volume connected to the outlet without any loss. In applications with great air consumption, such as the blowing, the indicated tolerance may change.	
Note 3:	The above apply when working pressure and control pressure are maximum	
Note 4:	The above apply when working pressure is maximum and the step is as follows: 50% F.S. -> 100%F.S. 50% F.S. -> 60% F.S. 50% F.S. -> 40% F.S.	

## GENERAL DATA ER104-9xxx

Model	ER104-9 0/1/2 X Analog type	ER104-9P X Parallel type
Fluid	Filtered air according to ISO 132	Filtered air according to ISO 132
Max. working pressure	10 bar	10 bar
Min. working pressure	Control pressure + Max. control pressure + 1 bar	Control pressure + Max. control pressure + 1 bar
Pressure control range	0,5 + 9 bar	0,5 + 9 bar
Class protection	IP40	IP40
Power supply voltage	DC24V ± 10% (stabilized power supply with a ripple rate of 1% or less)	DC24V ± 10% (stabilized power supply with a ripple rate of 1% or less)
Consumption current	0.15 A or less rush current 0.6 A or less when power is turned on	0.15 A or less rush current 0.6 A or less when power is turned on
Input signal (Input impedance)	0 a 10 VDC (6.7kΩ) 0 a 5 VDC (10kΩ) 4 a 20 mADC (250 Ω)	10 bit
Preset input	8 points	N/A
Output signal Note 1	Analog output 1-5 VDC (load to be connected impedance 500 KW or more ) Switch output NPN or PNP, open collector output, 30 V or less, 50 mA or less voltage drop 2.4.V or less, compatible for usage in PLC and Relay.	Analog output 1-5 VDC (load to be connected impedance 500 KW or more ) Switch output NPN or PNP, open collector output, 30 V or less, 50 mA or less, voltage drop 2.4.V or less, compatible for usage in PLC and Relay.
Error output signal	NPN or PNP, open collector output, 30 V or less, 50 mA or less, voltage drop 2.4 or less, compatible for usage in PLC and Relay	NPN or PNP, open collector output, 30 V or less, 50 mA or less, voltage drop 2.4 or less, compatible for usage in PLC and Relay
Direct memory setting	0,05 + 9 bar minimum input width 0,01 bar setting resolution 0,02 bar	0,05 + 9 bar minimum input width 0,01 bar setting resolution 0,02 bar
Hysteresis Note 2	0.5% F.S. or less	0.5% F.S. or less
Linearity Note 2	±0.3% F.S. or less	±0.3% F.S. or less
Resolution Note 2	0.2% F.S. or less	0.2% F.S. or less
Repeatability Note 2	0.3% F.S. or less	0.3% F.S. or less
Temperature characteristics: Zero point fluctuation	0.15% F.S./°C or less	0.15% F.S./°C or less
Temperature characteristics: Span point fluctuation	0.07% F.S./°C or less	0.07% F.S./°C or less
Max. flow rate Note 3	400 l/min (see diagram)	400 l/min (see diagram)
Step response time No load Note 4	0.82 sec. or less	0.2 sec. or less
Step response time 1000 cm³ load Note 4	0.8 sec. or less	0.8 sec. or less
Mechanical vibration proof	98 m/s² or less	98 m/s² or less
Ambient temperature	5°C + 50 °C	5°C + 50 °C
Fluid temperature	5°C + 50 °C	5°C + 50 °C
Connecting port size	G1/4	G1/4
Mounting direction	Free	Free
Weight	250g	250g
Note 1	Select either analog or switch output.	
Note 2	This characteristic is guaranteed within a regulation range between 10 and 90% of the full scale, with a power voltage of 24V±10%, a supply pressure of 1 bar higher compared with the set pressure (ex. regulation of 3 bar, supply pressure of 3+1 = 4 bar) and a volume connected to the outlet without any loss. In applications with great air consumption, such as the blowing, the indicated tolerance may change.	
Note 3	The above apply when working pressure and control pressure are maximum.	
Note 4	The above apply when working pressure and control pressure is maximum and the step is as follows: 50% F.S. -> 100%F.S. 50% F.S. -> 60% F.S. 50% F.S. -> 40% F.S.	

**STANDARD CODES**
**Models**

ER104-50AP	ER104-52AP	ER104-5PSP	ER104-90SP	ER104-92SP
ER104-50SP	ER104-52SP	ER 104-90AP	ER104-92AP	ER104-9PSP

**CODING EXAMPLE**

<b>ER</b>	<b>1</b>	<b>04</b>	<b>-</b>	<b>5</b>	<b>0</b>	<b>AN</b>
-----------	----------	-----------	----------	----------	----------	-----------

<b>ER</b>	SERIES
<b>1</b>	SIZE: 1 = size 1
<b>04</b>	PORT: 04 = G1/4
<b>5</b>	WORKING PRESSURE: 5 = 0 ÷ 5 bar 9 = 0.5 ÷ 9 bar
<b>0</b>	INPUT: 0 = 0 - 10 V DC 1 = 0 - 5 V DC 2 = 4 - 20 mA P = Parallel 10 bit
<b>AN</b>	OUTPUT: AN = 1 - 5 V analog, error (NPN ) AP = 1 - 5 V analog, error (PNP ) SN = switch (NPN ), error (NPN ) SP = switch (PNP), error (PNP)

DIAGRAMS

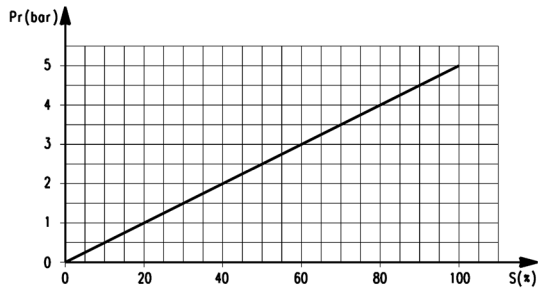

ER104-5xxx  
Input/Output characteristics

Pr = outlet pressure (bar)  
S = input signal (%)

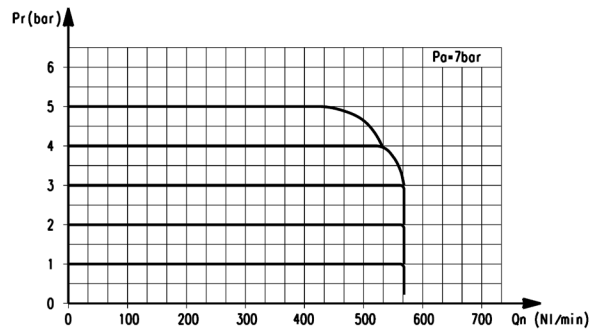

ER104-5xxx  
Flow characteristics

Pr = outlet pressure (bar)  
Qn = flow (l/min)  
Pa = operating pressure (bar)

DIAGRAMS

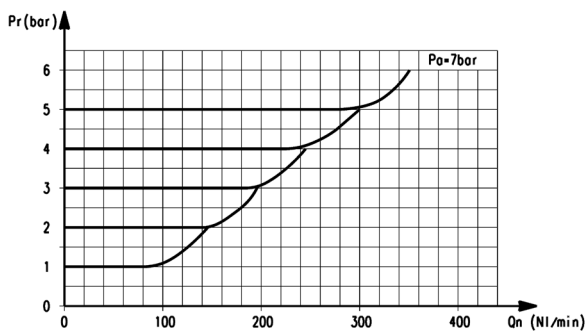

ER104-5xxx  
Exhaust characteristics

Pr = outlet pressure (bar)  
Qn = flow (l/min)  
Pa = operating pressure (bar)

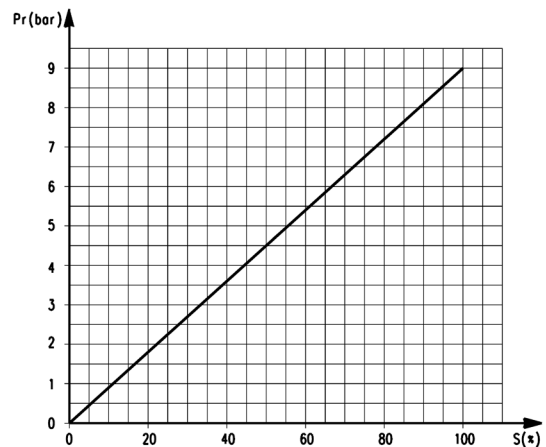

ER104-9xxx  
Input/Output characteristics

Pr = outlet pressure (bar)  
S = input signal (%)

DIAGRAMS

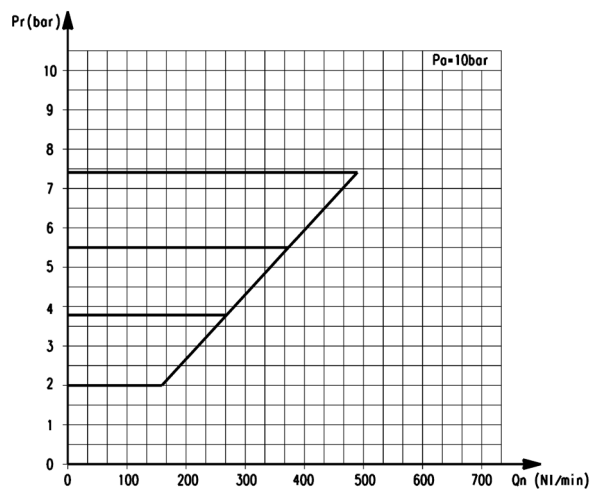
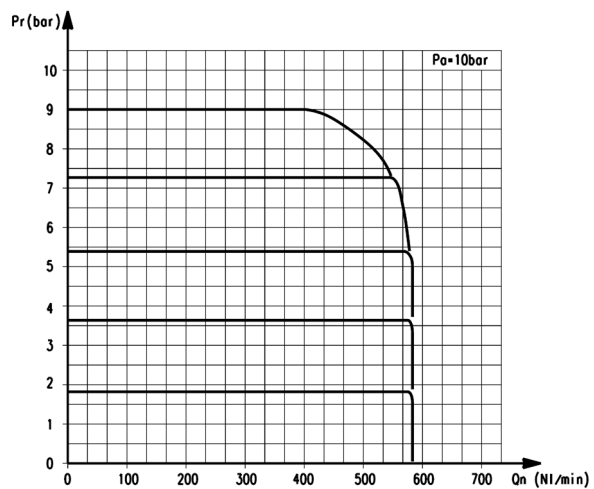

ER104-9xxx  
Flow characteristics

Pr = outlet pressure (bar)  
Qn = flow (l/min)  
Pa = operating pressure (bar)

ER104-9xxx  
Exhaust characteristics

Pr = outlet pressure (bar)  
Qn = flow (l/min)  
Pa = operating pressure (bar)

Proportional regulator Series ER100

See connectors on page 2/15.51.09

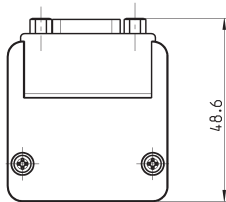
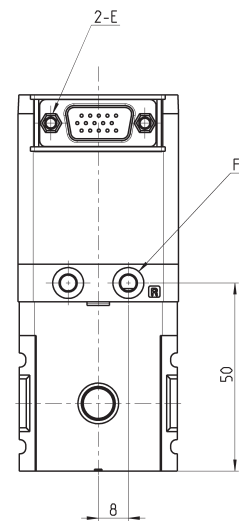
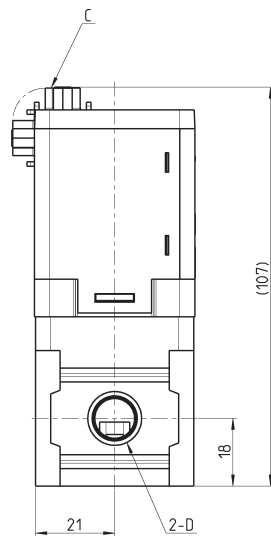
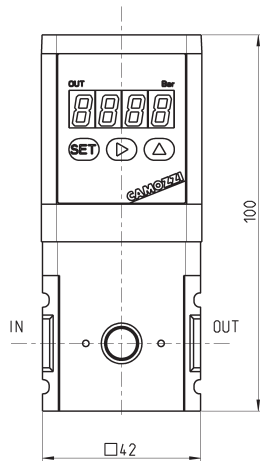
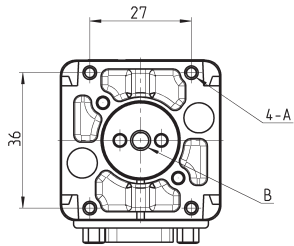
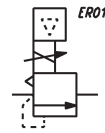

DIMENSIONS

Mod.	A	B	C	D	E	F
<b>ER104</b>	M3 depth 6	Ø5.3 EXH port	D sub-connector 15 pins/plugs	G1/4	4-40 UNC	Ø4.2 Port R (pilot air exhaust port)

**Bracket ER1-B1**

Floor installation type

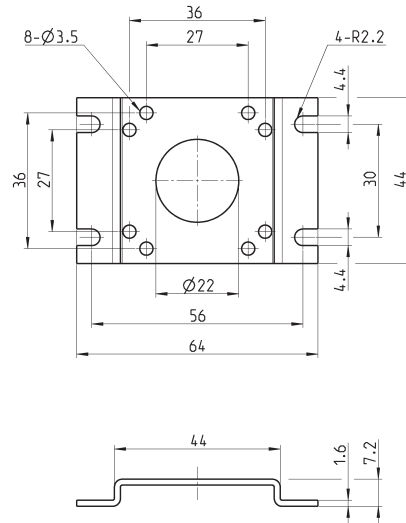
**DIMENSIONS**

Mod.

**ER1-B1**
**Bracket ER1-B2**

Wall installation type

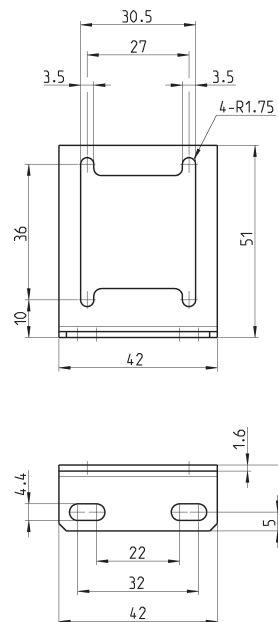
**DIMENSIONS**

Mod.

**ER1-B2**